

RESERVE

by SOUNDSTREAM

Owner's Manual EN

DEM UPGRADE HEAD UNIT FOR 2014+ HARLEY DAVIDSON® MOTORCYCLES



WHD14+

Safety First	
Safety Definitions	2
Pre-Riding	
Check list	3
Care and cleaning	3
Screen	3
Appearance	3
Before Installation	4
Panel Description	8
Wiring	9
Operation	
Main menu	11
Setting	11
Apple CarPlay/Android Auto	15
Radio operation	18
USB operation	18
Bluetooth Music	19
Bluetooth Phone	20
Camera in	21
Specification	22
Trouble Shooting	23
Warranty	24
FCC Notes	25

Safety Definitions

Statements in this manual preceded by following words are of special significance:

▲ WARNING

WARNING indicates a potentially hazardous situation which, if not avoided, could result in death or serious injury.

▲ WARNING

Set volume levels and other controls on audio and electronic devices before riding. Distractions can lead to loss of control, resulting in death or serious injury.

▲ WARNING

Do not select a volume level that blocks out traffic noise or interrupts the concentration necessary for the safe operation of the Motorcycle. Distractions or a volume level that blocks our traffic noise could cause loss of control resulting in death or severe injury.

Note

Pay attention while riding, keeping your eyes and clear mind on the road. Some features are locked out to prevent distraction, limited in capability while the Motorcycle is in motion. Even a part is available, donot allow it to distract you from operating your Motorcycle safely.

For safety, program the system when stopped. Perform system setup and get familiar with the controls and features of the infotainmentsystem before operating the Motorcycle on the road. This system cannot warn about the safety of an area, bad road conditions, and availability of emergency services.

Use this radio only in locations where it is safe to do.

Pre-RIDING

Check list

Configure the system with your personal preferences before riding to use features and minimize distractions while on the road entirely.

1. Set brightness, background.
2. Configure presets.
3. Adjust audio settings like EQ, volume, fade, balance etc. before riding.
4. Pair, connect and set up phone features through Bluetooth.
5. Connect USB devices for Apple CarPlay® or Android Auto®.
6. Select station or media

CARE AND CLEANING

Use only **WHD14+** recommended products and methods to keep the radio, speakers, and other audio system components clean and in good condition.

Do not use any abrasives, polishes, or rubbing compounds to clean the screen or other components. Do not use any ammonia-based cleaners on the net.

The use of other products or methods may cause damage to components.

Screen :

Do not use any chemical cleaners or chemical-containing wipes or cloths. These can cause damage to the screen surface.

Gently clean the display glass surface with a clean, dry microfiber cloth. Before cleaning, it is suggested to remove any visible dust, dirt, sand particles with a gentle compressed airstream.

Appearance

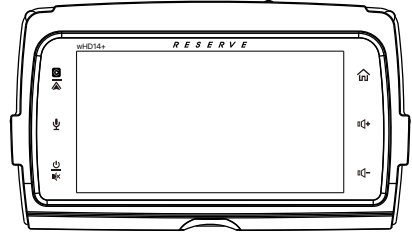

Front

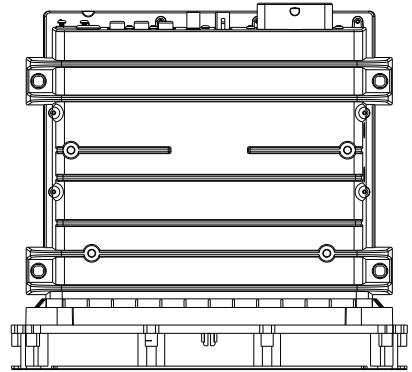

Top

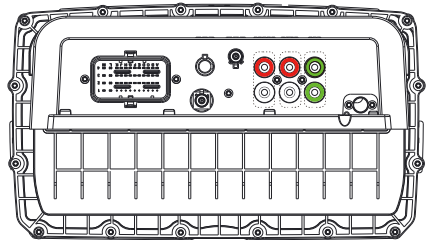

Back

REMOVAL OF ORIGINAL HEAD UNIT

Street Glide

To prevent accidental vehicle start-up, which could cause death or serious injury, remove main fuse before proceeding.

1. Remove three outer fairing bolts using a T27 Torx screw driver. The three outer fairing bolts are located below the windshield. Remove the windshield, store it and the screws removed in a safe place for re-installation later.



TIP: Reinstalling the center screw after removing the windshield will prevent the outer fairing from falling during the next step. A few turned by hand will be sufficient.

2. Remove four inner fairing bolts using a T27 Torx screw driver. The four inner fairing bolts are located adjacent to each turn indicator mounting bracket and below/adjacent to each speaker. Store these screws in a safe place for re-installation later.



3. While straddling the front wheel fender, grasp the outer fairing, remove the center outer fairing bolt from the previous step, then gently pull the fairing apart from the bike. With the fairing slightly pulled away from the bike, disconnect wire harness for the headlamp and any other accessories. Lay the fairing on a protected flat surface to prevent damage.

4. Remove upper support bracket. Removal of the upper support bracket requires removing 11 screws:

4.1) remove four 5/32 allen screws attaching the bracket to each speaker enclosure (1)

4.2) remove two T25 screws attaching the bracket to the inner fairing adjacent to the gauge cluster (2)

4.3) remove four T25 screws attaching the bracket to the head unit chassis (3)

4.4) remove one T25 screw attaching the bracket to the media compartment (4)

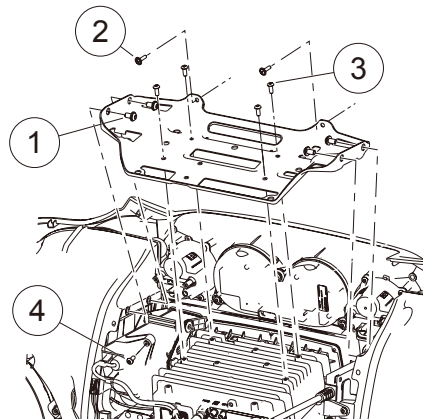

Installation

5. Disconnect electrical connections to the head unit.

5.1) Remove the main wire harness connector (1). To remove the main wire harness, depress the latch lock with a small flathead screwdriver and swivel the latch aside. Pull the wire harness connector to remove from the socket.

5.2) Remove the USB cable connector (2). To remove the USB cable connector, depress the locking tab with a small flathead screwdriver. While depressing the locking tab, pull the USB cable to release it from the socket.

5.3) Remove the radio antenna cable connector (3). To remove the radio antenna cable connector, depress the locking tab with a small flathead screwdriver. While depressing the locking tab, pull the antenna cable to release it from the socket.

5.4) Remove the GPS antenna cable connector (4). To remove the GPS antenna cable connector, depress the locking tab with a small flathead screwdriver. While depressing the locking tab, pull the antenna cable to release it from the socket.

5.5) Remove SiriusXM antenna cable connector, if equipped (5). To remove the Sirius XM antenna cable connector, depress the locking tab with a small flathead screwdriver. While depressing the locking tab, pull the Sirius XM antenna cable to release it from the socket.

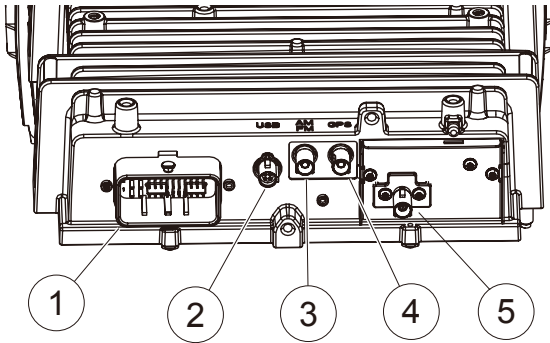

6. Remove four head unit mounting screws using a 3/16" hex driver. Two screws are located at each side of the headunit chassis. Store these screws in a safe place for re-installation later. Pull the headunit assembly up and forward to remove.

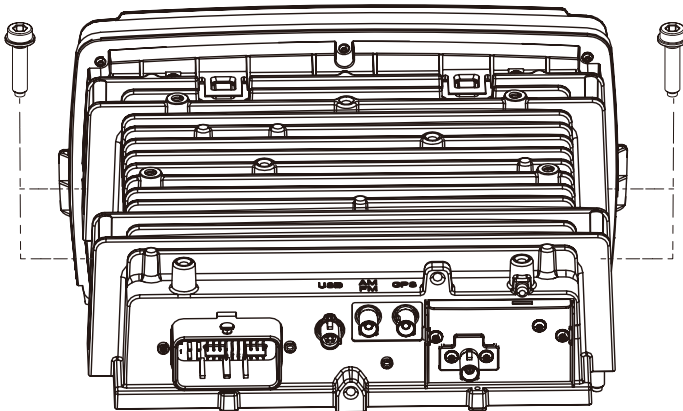

REMOVAL OF ORIGINAL HEAD UNIT

Road Glide

To prevent accidental vehicle start-up, which could cause death or serious injury, remove main fuse before proceeding.

1. Detach each turn signal / indicator light by removing the adjacent allen socket screw, using a 3/16" allen head driver. Store these screws in a safe place for re-installation later.



2. Remove four inner fairing bolts using a T25 Torx driver. Two inner fairing bolts are located below each glove box, adjacent to each wind deflector. Store these screws in a safe place for installation later.

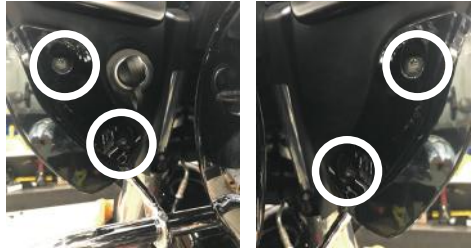

3. Remove four windshield bolts using a 1/8" allen driver or Philips screw driver and remove the windshield. Also remove factory vent by pulling straight up on the vent. The vent comes snapped in place. Store the screws in a safe place for installation later.



4. After removing the vent, locate and unplug the 3-pin wire harness for the left and right side turn signal indicator. These harness' are adjacent to each side of the head unit.



5. Remove an additional inner fairing bolt with a T27 Torx or 5/32" allen driver, one behind each speaker grill. Remove the speaker grill by wedging a plastic/nylon pry tool between the inner fairing and grill edge, popping it outward. Once these bolts are removed, the outer fairing will be detached from the inner fairing. Store these screws in a safe place for installation later.



6. While straddling the front wheel fender, grasp the outer fairing. Gently pull the fairing apart from the bike. With the fairing slightly pulled away from the bike, disconnect wire harness for the headlamp or any other accessories. Lay the fairing on a protected flat surface to prevent damage.

7. Remove two upper support bracket screws using a 3/16" allen driver. Store the bracket and screws in a safe place for re-installation later.

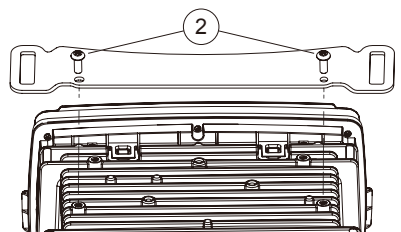

Installation

8. Disconnect electrical connections to the head unit.

8.1) Remove the main wire harness connector (1). To remove the main wire harness, depress the latch locking tab with a small flathead screwdriver. While depressing the locking tab, pull the USB cable to release it from socket.

8.2) Remove the USB cable connector (2). To remove the USB cable connector, depress the locking tab with a small flathead screwdriver. While depressing the locking tab, pull the USB cable to release it from socket.

8.3) Remove the radio antenna cable connector (3). To remove the radio antenna cable connector, depress the locking tab with a small flathead screwdriver. While depressing the locking tab, pull the antenna cable to release it from the socket.

8.4) Remove the GPS antenna cable connector (4). To remove the GPS antenna cable connector, depress the locking tab with a small flathead screwdriver. While depressing the locking tab, pull the antenna cable to release it from the socket.

8.5) Remove SiriusXM antenna cable connector, if equipped (5). To remove the Sirius XM antenna cable connector, depress the locking tab with a small flathead screwdriver. While depressing the locking tab, pull the Sirius XM antenna cable to release it from the socket.

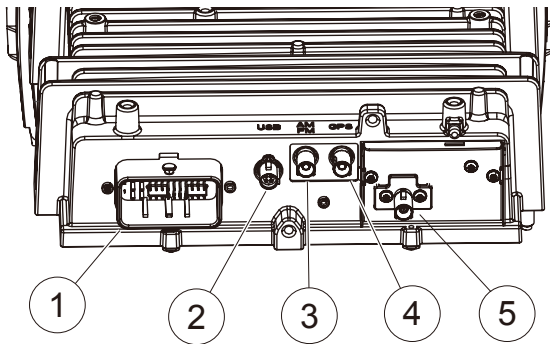

9. Remove four head unit mounting screws using a 3/16" hex driver. Two screws are located at each side of the headunit chassis. Store these screws in a safe place for re-installation later. Pull the headunit assembly up and forward to remove.

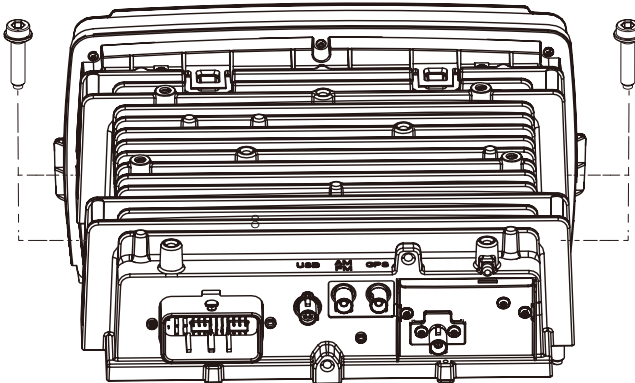

Panel description

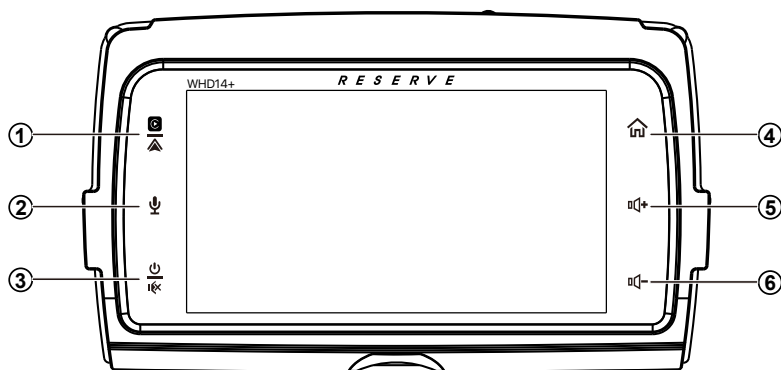

1 Apple CarPlay® / Android Auto®

Press to enter CarPlay® / Android Auto® directly(When the iPhone/Android phone is connected).

2 Siri Button (Voice Recognition)

When the iPhone/Android phone is connected, press **Siri** button to start the voice control function.

3 Power / Mute

- When the power is off, press to power on.
- When the unit is working, short pressing for Mute, press again for unmute.
- Pressing and hold to turn the source unit power off.

4 Home button

- Press to toggle between Home screen and active media.
- Available selections: Radio, Apple CarPlay®/Android Auto®, BT Music, BT Phone, USB,Settings, Camera in.

5 Volume +

- Press to increase the volume value.

6 Volume -

- Press to decrease the volume value.

Wiring

To prevent accidental vehicle start-up, which could cause death or serious injury, remove main fuse before proceeding.

1. Install WHD14+ into the location of the OEM head unit. Secure the chassis to the OEM mounting location with the four bolts removed during the last step of REMOVAL OF ORIGINAL HEAD UNIT section using a 3/16" allen driver.

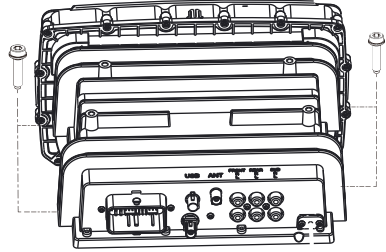

2. Connect the OEM USB and radio antenna cables disconnected during removal of the OEM head unit to the matching sockets on the back of WHD14+. If either are difficult to connect, verify the orientation of the connector(s) is correct. If any aftermarket audio amplifiers will be used in the audio system, take a moment to connect the RCA cables to the corresponding audio outputs. Although not required, if the Bluetooth calling microphone will be used, secure it to the desired installation location, then route its cable to the corresponding input on the back of WHD14+.

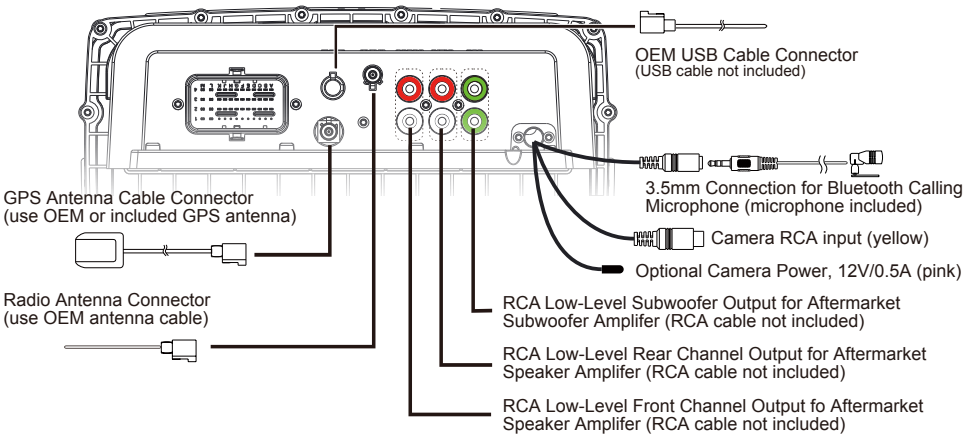

3. Insert and lock the male OEM head unit wire harness connector to the female socket of the included wire harness for WHD14+. Then, insert and lock the male connector of the WHD14+ wire harness into the corresponding female socket on the back of WHD14+.

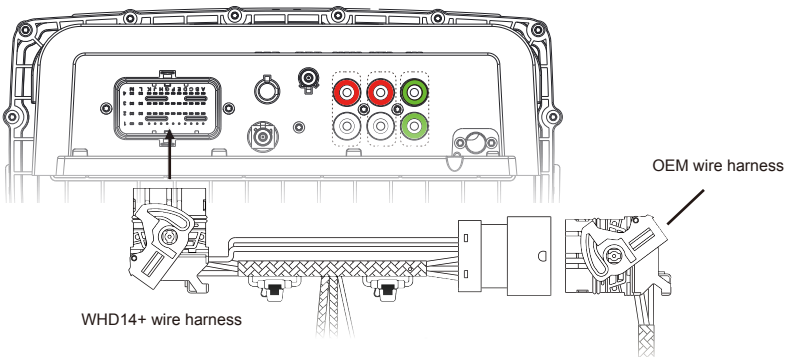

Wiring

Included Harness

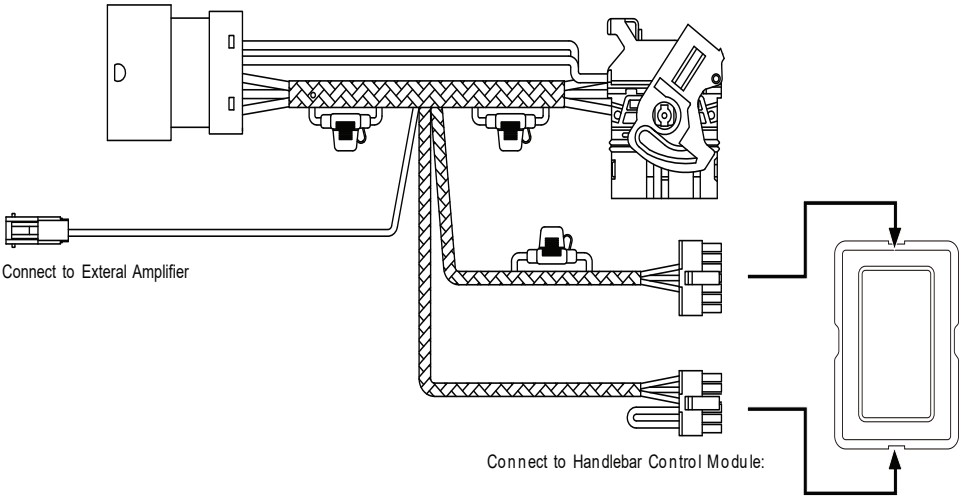

48 PIN CONNECTOR

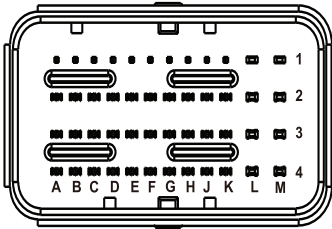

- | | |
|---------------------------------|-------------------------|
| E4. Pink/White.....UART-SPEED | L1. White/Black.....FL- |
| F4. Gray/White.....UART-TX | L2. White.....FL+ |
| G4. Blue/White.....UART-RX | L3. Black.....Ground |
| H1. Green/Black.....RL- | L4. Black.....Ground |
| H4. Red/White.....UART-12V | M1.Gray.....FR+ |
| J1. Green.....RL+ | M2.Gray/Black.....FR- |
| J3. Orange/White...Illumination | M3.Yellow.....Battery+ |
| J4. Black/White.....UART-GND | M3.Yellow.....Battery+ |
| K1. Purple.....RR+ | |
| K2. Purple/Black.....RR- | |
| K3. Blue.....ANT | |
| K4. Red.....ACC | |

Wiring

4. If an alternative handlebar integration module other than Scosche is available, skip this step and proceed to step 5. If included, connect the Scosche handlebar integration module to the corresponding 12-pin and 14-pin connectors on the wire harness of WHD14+.

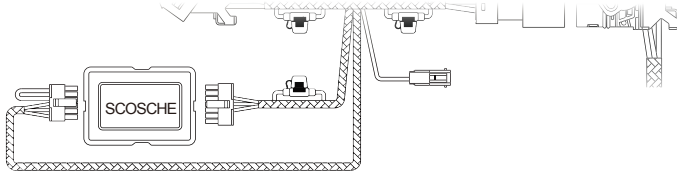

5. If an alternative handlebar integration module is available, cut the wires leading to the 12-pin and 14-pin connectors and discard them. Follow the color coded call-out below to connect the wires of WHD14+ wire harness to the corresponding inputs and outputs of the alternate handlebar control module.

14-Pin Connector

- Red.....ACC turn-on
- Orange/White.....Illumination
- Violet/White.....CAN -
- Green/White.....CAN +
- Black.....Ground
- Yellow.....12V

12-Pin Connector

- Black/White.....Key/SWC Ground
- Green/White.....Key/SWC 1
- Grey/White.....Key/SWC 2

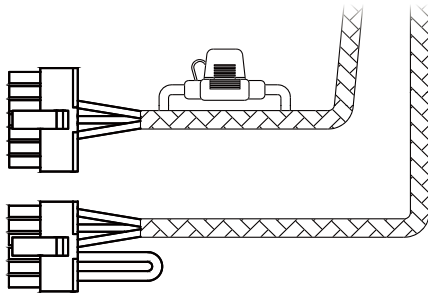

6. Double check all connections are complete and secure. Reassemble the fairing support bracket using the original screws to the corresponding screw holes on top of WHD14+. Then, reassemble the fairing by reversing the model specific instructions covered in **REMOVAL OF ORIGINAL HEADUNIT**.

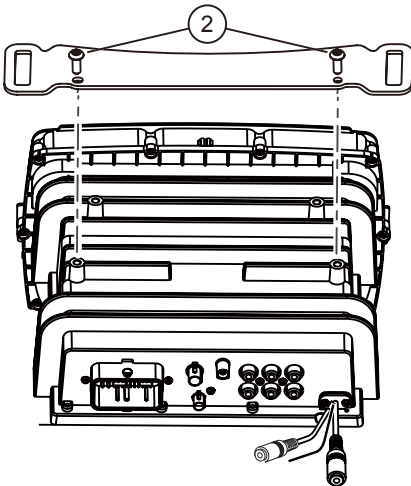

ROAD GLIDE

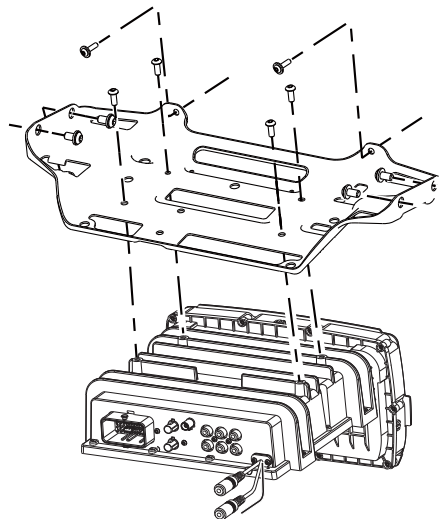

STREET GLIDE

Handlebar control the headunit:

This **WHD14+** for select 2014+ touring motorcycles can retain factory handlebar controls using **HDHU.14HCM** SWC modules.

Left HandControl

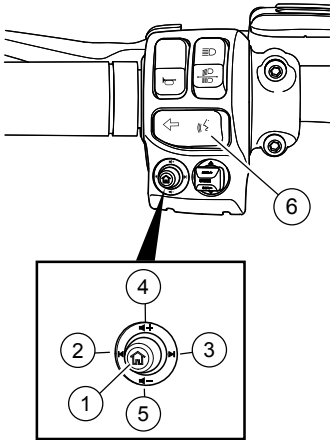

ITEM	ICON	NAME	FUNCTION
1		Mode	Source change.
2		Previous /SeekDown	Media: Previous track. Tuner: Tune/seek down.
3		Next/Seek Up	Media: Next track. Tuner: Tune/seek up.
4		Volume Up	Increases volume.
5		Volume down	Decreases volume.
6		Voice Control	Voice Control(CarPlay/Android Auto)
		Pick up/Hang up	When phone call incoming: Short press for pick up. Long press for hang up.
		Hang up	When phone call connected: Long press for hang up.

RightHandControls

ITEM	ICON	NAME	FUNCTION
1		Mode	Source change.
2		N/A	
3		N/A	
4		Volume Up	Increases volume.
5		Volume down	Decreases volume.
6		Mute	Mute/ Press again for Un-mute.

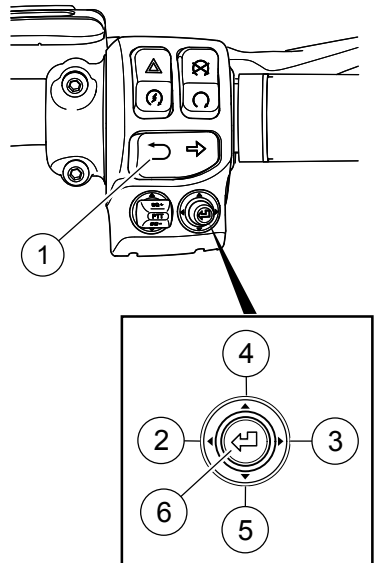

Main Menu

WHD14+ is a headunit for Motorcycle with the following functions:

Wireless / Wired Apple CarPlay®, Wireless / Wired Android Auto®, Radio, USB, BTMusic, Phone, Camera.

Touch the corresponding Mode icon to enter playing mode. The Mode icon in gray means the corresponding function is not ready, or the proper device has not been connected.

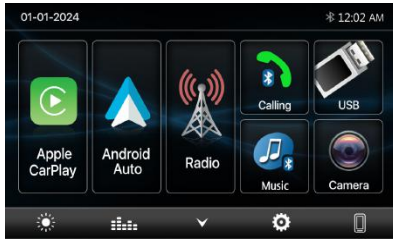

Hidden soft button bar:

A hidden pop up soft button bar is located at the bottom. Touch the icon ▲ to shown the soft button bar. Touch the ▼ to hidden.

- Dimming, to change Daylight or Night.
- EQ, to enter the Equalizer setting menu.
- Hidden, to hide the bottom buttons.
- Setup, to enter the Settings Menu.
- Device List, to enter the device list page.

Touch the icon to enter the Setup menu.

The Setup menu is included **System Settings, Audio & EQ Settings, Display Settings, Bluetooth Settings.**

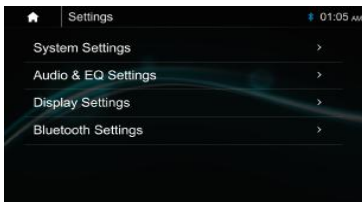

Settings

System Settings:

The **System Settings** allow the user to set up the **Language, Date & Time, Key Beep, GPS Status, Factory Reset and About.**



Language:



Date & Time:

To setting Time format (12H or 24H), setting the date and time



GPS Status:

Show the current available GPS satellite quantity.

Key Beep: On / Off

To set the touch button beep tone is On or Off.

Factory Setting:

To default the default factory settings:



Tap "OK" to reboot the headunit.

Settings

About:

To display the WHD14+ MCEU, SOC, hardware and firmware version, and the headunit's serial number.



How to Update:

1. Download the newest Firmware Update and Save to Computer. After downloading, make sure the compressed-files are unzipped and are copied onto a blank USB Flash Drive (**64GB Max**) on the Root Directory File of USB Flash Drive.
2. Insert USB stick and select the "Settings Icon" from the Home Screen.
3. Select "System Settings" Tab at top, then next screen select "About" button.
4. Select "Update" and on next screen, select "Update" Again.
5. ((Wait for both Updates to complete)) Headunit will restart itself once both updates are complete. New Firmware Info:xxx

Note:

Use a good quality flash drive to successfully execute this update.

Not all USB flash drives are the same.

Use a flash drive with Type-A connector.

The USB port Harley Davidson built into your bike is Type-A. Your flash drive needs to be Type-A also.

Flash drives with USB Type-C connectors, Type-C to Type-A adapter cables, etc. should not be used.

Although more convenient, they increase the chances of corruption or failed data transfer.

Format your flash drive before saving the update.

Before downloading the update to your flash drive, format it using FAT32 file format. This can be done by the disk drive tools of your PC/iOS computer. Be sure to copy any files previously saved on the flash drive before formatting as this process will erase any files previously saved. This fresh formatting of your flash drive will reduce the chances of data corruption or errors when saving & uploading the update.

Use a good quality flash drive from a reputable manufacturer.

Avoid flash drives you might have gotten as a freebie from a vendor at a rally, part of a novelty key chain/toy, from a \$1 container at your local convenience store, etc. These tend to be poorer quality, have slower data transfer rates, and are more likely to crash during downloading or uploading. If the data transfer to your HDHU fails during the process, it is possible the computer inside your HDHU will become corrupt, and it may not be recoverable.

Audio & EQ Setting

Below shown is the Audio setting Menu.



Balance/Fader:

Touch the + or - of Balance/Fade to tune for the driver and passenger preference.

The value of **Balance (Left 12 – Right 12)** and **Fader (Front 12 – Rear 12)**.

Touch **Reset** to set both **Balance** and **Fader** to **0**.



13-Band Equalizer:

13-band of EQ tuning, slide the **EQ** bar to tune each band frequency level according to user preference.

Touch **Reset** button to set all Band to **zero**.

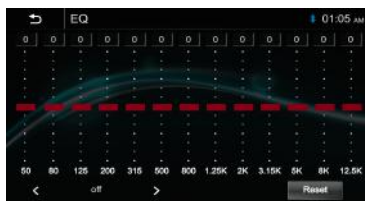

Touch "<" or ">" to select the preset equalizer: **Rock > Pop > Electric > Jazz > EQ Custom > off**.

About the Crossover

This unit is equipped with an active crossover. The crossover limits the frequencies delivered to the outputs.

The crossover adjusts the HPF (high pass filter) or LPF (low pass filter) of speakers and subwoofer, and also the slope (how fast the filter rolls off the highs or lows).

Adjustments should be made according to the reproduction characteristics of the speakers. Depending on the speakers, a passive network may not be necessary. If you are unsure about this point, please consult your authorized Soundstream dealer.

- **HPF (high pass filter):** Cuts the lower frequencies and allows the higher frequencies to pass.
- **LPF (low pass filter):** Cuts the higher frequencies and allows the lower frequencies to pass.
- **Slope:** The level change (in dB) for a frequency change.
- The higher the slope value, the steeper the slope becomes.
- **Adjustment:** should be made according to the recommended crossover frequency of the connected speakers. Determine the recommended crossover frequency of the speakers. Adjusting to a frequency range outside that recommended may cause damage to the speakers.

For the recommended crossover frequencies of speakers, refer to the respective Owner's Manual. We are not responsible for damage or malfunction of speakers caused by using the crossover outside the recommended value.

Front/ Rear Crossover:



Slope: 12dB / 24dB

User can touch "<" or ">" to select the desired frequency Value.

Subwoofer Settings:



- Subwoofer Output:** ON or OFF.
- Subwoofer Level:** -10~+10
- Subwoofer Crossovers:**
- Subwoofer Phase:** 0° or 180°.

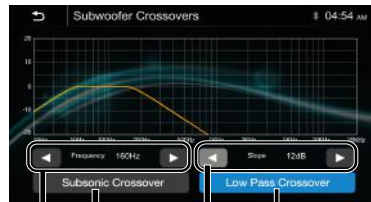

Set Low Pass Crossover Frequency & Slope.

Slope: 12dB / 24dB
Set Subsonic Crossover Frequency.

User can touch "<" or ">" to select the desired frequency Value.

AMP Turn-on Delay: ON /OFF.

User can set **AMP Turn-on Delay** is ON or OFF.

Volume setting:



Source Level Adjust:



User can adjust the source mode (**Radio, USB, BT Audio, Apple CarPlay, Android Auto**) gain value. The gain can be adjusted from -5~+5 seperately.

Maximum Volume Adjust:



User can select Maximum Volume is On / Off. When select ON, user can set the desired Maximum Volume level.

Display setting:

Below is the Display setting menu, user can select *Nighttime Brightness*, *Touch Key Color*, *Background Wallpaper*.





Nighttime Brightness : -8 – 0. (Default is 0).

Touch Key Color



LED Auto(Changing Color) : On/Off.

ON: The Led color will change automatically.

OFF: You press the button  or  to select desired color.

Color: White / Red / Orange / Yellow / Blue / Green / Purple / Cyan.

Background Wallpaper:

User can select the preset wallpaper or select prefer picture in USB driver as the wallpaper.



Touch the corresponding picture to select the prefer background.

Touch "+", the head unit will search the USB photo file for wallpaper.

Select a picture and touch OK to add the wallpaper.



Select another picture for replacing the current wallpaper.

Bluetooth Settings:

Touch the Bluetooth Settings from the setting menu will be shown below:



Bluetooth: On/Off (Select Bluetooth connection is On or Off).

Pairing: To start the pairing.



BT Address : Shown headunit BT Address.

Device Name : WHD14+.

Clear Records: To clear the device list records.

Apple CarPlay® & Android Auto®

Apple CarPlay :

You can operate iPhone applications with finger gestures such as tapping, dragging, scrolling, or flicking on the screen of this product.

Compatible iPhone models

For details about compatibility of iPhone models, refer to the following website.
<https://www.apple.com/ios/carplay>

WARNING

Certain uses of the iPhone may not be legal while driving in your jurisdiction, so you must be aware of and obey any such restrictions. If in doubt as to a particular function, only perform it while the car is parked. No feature should be used unless it is safe to do so under the driving conditions you are experiencing.

Notes on using Apple CarPlay

- iPhone with iOS 7.1 or later is required. Update to the latest iOS version before use.
- Apple CarPlay can be used on iPhone 5 or later.
- For details on compatible models, refer to the compatibility list on the support site on the back cover.
- For details about Apple CarPlay, refer to the manual supplied with your iPhone, or visit the website of Apple CarPlay.
- Since the GPS on your iPhone is used, place your iPhone where it can easily receive a GPS signal
- You can use Siri function by touching  button once Apple CarPlay is activated
- The Bluetooth connection with the Apple CarPlay compatible device will be terminated automatically if Apple CarPlay is turned on.
- Hands-free phoning via Bluetooth wireless technology is not available while Apple CarPlay is on.

Starting procedure of using Apple CarPlay

- 1 Connect an Apple CarPlay compatible device to this unit via USB.
- 2 Touch the Apple CarPlay icon.
The Apple CarPlay home screen appears.

You can use Apps of connected iPhone. The items displayed and the language used on the screen differ among the connected devices.
To enter the Apple CarPlay mode, touch Apple Carplay icon on the Home selection screen.



① Application keys

Start the application.

②

Display the home screen of Apple CarPlay. Touch and hold to activate Siri.

③ Home

Exit the Apple CarPlay screen and displays Home screen.

* The icon design may change depending on the iOS version.

How to connect Wireless Apple CarPlay

Starting procedure of using Wirelessly Apple CarPlay

Before using Apple CarPlay wirelessly, turn on the Bluetooth function on the iPhone.

- 1 On the Main menu tap the  icon access to Device Link interface.

Show below pop-up menu, tap **YES** start to search the available devices.

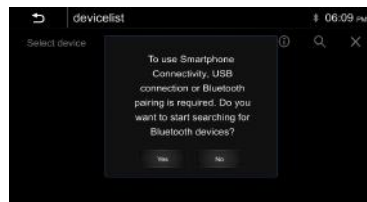

Below pop-up menu will be shown:

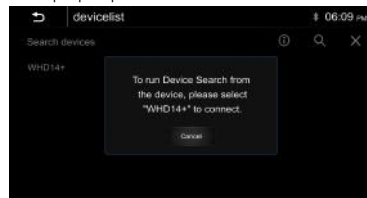

The user use the iPhone search the device via Bluetooth ,then follow the pop notice step by step to connect

1. Turn on your iPhone's Bluetooth and Wi-Fi, and connect to WHD14+.

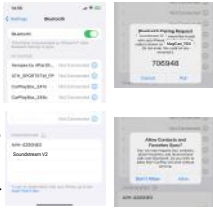

a. Go to Settings > Bluetooth and the phone should be able to find a Bluetooth Device(WHD14+).

b. A Bluetooth Pairing Request will be displayed on the screen with a specific code which should match what is shown on. Tag "Pair" for connecting.

c. Immediately following the Pairing notification, a new request to "Allow Contacts and favorites Sync" on your iPhone, Allow in order to have caller ID and access to your contacts through CarPlay.

Note: Following the BT connection, there is no need to try and connect WIFI manually (although it does need to be ON), after the BT connection process is complete, the WIFI will connect automatically on its own.

3.Wait for a moment for CarPlay connection, click use CarPlay and enter the UI interface.

4. iPhone will pop-up prompts, click "Use CarPlay".



2. When the headunit detect the available device, follow the pop-up notice step by step to connect the iPhone. After connected, will show below page:

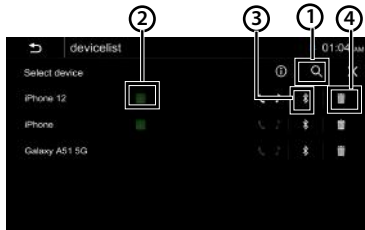

1. Tap to start to search new device.
2. Tap to access Apple CarPlay interface.
3. Tap to access Bluetooth interface.
4. Tap to delete current device.

Android Auto®:

You can operate Android applications with finger gestures such as tapping, dragging, scrolling, or flicking on the screen of this product

Starting procedure of using Android Auto

- 1 Connect an Android Auto™ compatible device to this unit via USB.
 - 2 Touch the Android Auto icon.
- The Android Auto home screen appears

Note: You can use Voice function by touching  button once Android Auto is activated.

- The Bluetooth connection with the Android Auto compatible device will be terminated automatically if Android Auto is turned on.
- Hands-free phoning via Bluetooth wireless technology is not available while Android Auto is on.

Notes on using Android Auto

- Android phone with Android 5.0 or higher is required. Update to the latest OS version before use.
- Your Android phone needs to support Android Auto. For details on compatible models, refer to the compatibility list on the support site on the back cover.
- Download the Android Auto app on Google Play.
- For details about Android Auto, refer to the manual supplied with your Android phone, or visit www.android.com/auto
- Since the GPS on your Android phone is used, place your Android phone where it can easily receive a GPS signal.
- Android Auto may not be available in your country or region.the website of Android Auto.



① Application keys

Start the application.

② Home

Exit the Android Auto screen and displays Home screen.

③ Operation Bar

Starts the application or displays information.

Apple CarPlay® & Android Auto®

How to connect Wireless Android Auto Starting procedure of using Wirelessly Android Auto

1 On the Main menu tap the  icon access to Device Link interface.

Show below pop-up menu, tap **YES** start to search the available devices.

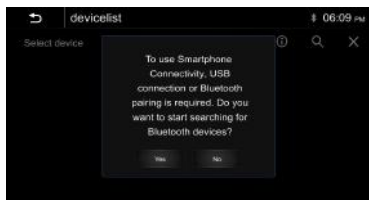

Below pop-up menu will be shown:

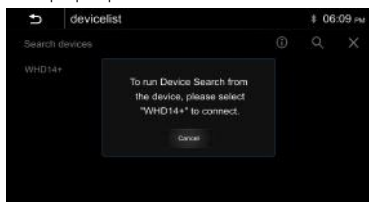

When the headunit detect the available device, follow the pop-up notice step by step to connect the iPhone. After connected, will show below page:

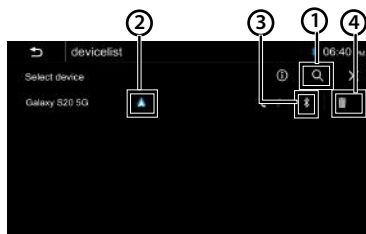

1. Tap to start to search new device.
2. Tap to activate Android Auto interface.
3. Tap to activate Bluetooth interface.
4. Tap to delete current device.

Note: Following the BT connection, there is no need to try and connect WIFI manually (although it does need to be ON), after the BT connection process is complete, the WIFI will connect automatically on its own.

- 3.Wait for a moment for Android Auto connection, click use Android Auto and enter the UI interface.
4. Android Phone will pop-up prompts, click "Use Android Auto".

The user also can use the Android Smartphone search the device via Bluetooth , then follow the pop notice step by step to connect wireless Android Auto.

1. Turn on your phone's Bluetooth and Wi-Fi, and connect to WHD14+.

a. Go to Settings > Bluetooth and the phone should be able to find a Bluetooth Device(WHD14+).

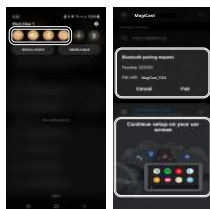

b. A Bluetooth Pairing Request will be displayed on the screen with a specific code which should match what is shown on. Tag "Pair" for connecting.

c. Immediately following the Pairing notification, a new request to "Allow Contacts and favorites Sync" on your Android smartphone, Allow in order to have caller ID and access to your contacts through Android Auto.

Touch "Radio" in the main menu to enter the radio interface.

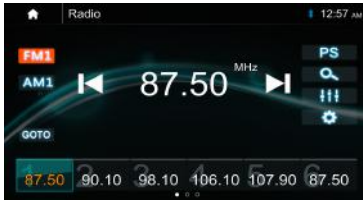

Touch "FM" can change between FM1>FM2>FM3.

Touch "AM" can change between AM1>AM2.

Touch "GOTO" then Pop-up the GOTO menu and enter the desired Frequency Number.

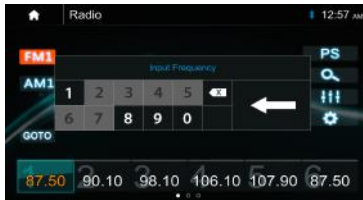

Touch for Prescan search, each scanned station will be played for 10 sec, touch again to stop. Touch to auto scan searching.



Touch to enter EQ settings.



Touch to enter Radio settings.



Short touch to seek down, long touch to tune down.



Short touch to seek up, long touch to tune up.

Preset channel, six preset buttons store and recall stations for each band. Touch and slide the preset channel can switch to next band FM1/FM2/FM3 or AM1/AM2.

Store a Station

1. Tune radio to desired station.
2. Touch and hold the one of the preset station for more than 3 seconds, then the preset button will be highlighted on the screen, and the preset station will be stored.

Radio setting:

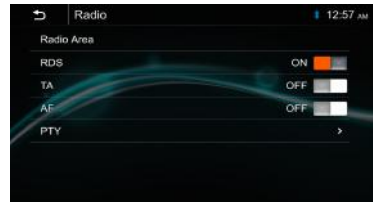

Radio Area: Select the region, America/Europe /Eastern Europe /Japan /Southeast Asia /Latin America/ Asia / Australia.

RDS: Switch ON or OFF.

TA: Switch ON or OFF.

AF: Switch ON or OFF.

PTY: Enter PTY list.

Note: AF is only for Europe region.

PTY Information:

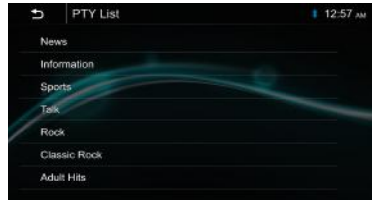

USB

Plug the USB; the USB icon will be colorful. Touch the USB icon to enter the USB playback mode. The source unit will playback the audio in the USB device.



Press to go to the following folder.



Press to search Audio/Image files.



Press to go to the previous folder.



Short press to skip previous track. Long press to fast reverse.





Play or Pause button.









Short press to skip next track. Long press to fast forward.

USB

-  Press to select Repeat All> Repeat 1> Repeat Folder.
-  Press to switch Random is On or Off.
-  Press to select Audio setting or set the preferred EQ of each band in custom mode.

Picture Playback





-  Press to search Audio/Image files.
-  Press to repeat playback all the pictures.
-  Press to browse previous picture.
-  Play or Pause button.
-  Press to browse next picture.
-  Press to rotate 90 degree anticlockwise.
-  Press to rotate 90 degree clockwise.

File List Browsing

Touch  to browse the folder and file list of the USB device.









-  Select Audio or Music files.
-  Select Picture files.
-  Return to playing previous file.

Bluetooth Music

Bluetooth Music:

Touch the BT Music icon to enter Bluetooth Music playing mode. If the Bluetooth is connected, the music will be playing as below shown:



-  Short press to skip previous track.
-  Play or Pause button.
-  Short press to skip next track.
-  Press to select Repeat All> Repeat 1> Repeat Folder.
-  Press to switch Random is On or Off.
-  Press to select Audio setting or set the preferred EQ of each band in custom mode.

Bluetooth Connect:

If the Bluetooth is not connected, press Reconnect the paired Phone or pairing to pair the new device.



Bluetooth Pairing:

Pairing screen will be shown as below:



Turn on the Bluetooth of the Mobile phone/ Bluetooth device; you can see the "WHD14+." Select the "WHD14+" for pairing and connection.







Bluetooth Phone

Bluetooth Phone:





After the mobile Phone is connected with the source unit via **Bluetooth(HFP)**, the user can go through the source unit.

Make a phone call. Touch the Phone icon in Main Menu to go to BT Phone mode. Please note it needs to connect the microphone for phone calls.





-  Keypad. Tap it to enter call mode.
-  History. Tap it to show the call record, missed, received and dialed calls.
-  Contact. Tap it to show the phonebook of connected device.
-  BT Setup. Tap it to set Auto answer and Microphone gain.
-  Make a call or Accept the incoming call.
-  Backspace, tap it to clear the incorrect dial digit.

Make a Call:



1. Touch the  icon to enter dial screen.
2. Using the keypad, touch 0-9,*,#, enter the desired number to dial. If you input an incorrect number, touch the  icon on the keypad to delete the incorrect number.
3. Once the correct number appears on the screen, touch the  icon to go to dialing interface.
4. To end the call, touch the icon  on the screen.



-  Interchange between phone and source unit.
-  ON / OFF the Microphone function.
-  Display the Keypad.

Receive an incoming call:

If the Phone is connected with the source unit via Bluetooth, when an incoming call, below screen will be shown:

- Press  to answer the incoming call.
- Press  to reject the incoming call.



History:

Touch the  icon to display the call combined list.

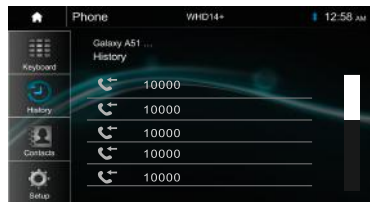

Slide the bar at the right up and down to display a call logs.

Contacts:

Touch the icon  to access the phone book of the connected mobile Phone. To make a call from the phonebook, simply touch the contact's name

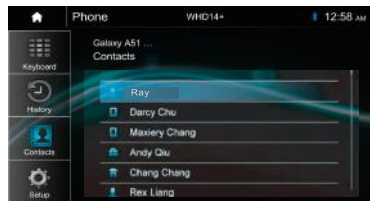

BT Setup:



Auto Answer On/Off, incoming call auto answer.

MIC Gain: Low /Middle /High

Camera View

For connecting a camera.

Displaying the picture from the Camera

The camera view screen is displayed when you enter the Camra in.



Specification

GENERAL

Power Requirement:

Power Requirement:

Current Drain:

Maximum Power Output:

RMS Power Output:

Speaker Impedance:

Frequency Response:

Operating temperature:

Dimensions:

DC 10 - 16Volts,

Negative ground

15A (Max.)

50Watts x 4

25Watts x 4

2- or 4-Ohm Load

20Hz ~20KHz

-20~60 C

230mm(W) x 210mm(D)x 140mm(H)

TFT Display

TFT Screen size:

Resolution

7 – Inch TFT/LCD

1024x600 pixels

FM RADIO SECTION

Frequency Range

87.5 – 107.9 MHz (America)

87.5 – 108 MHz (Europe)

Usabe Sensitivity (S/N=30dB)

≤ 15dB

S/N Ratio:

≥ 55dB

Stereo Seperation

≥ 30dB

AM RADIO SECTION

Frequency Range

(America) 530 – 1710 KHz

(Europe) 522 – 1620 KHz

Usabe Sensitivity (S/N=20dB)

≤ 40dB

S/N Ratio:

≥ 45dB

Line-out / Subwoofer Output

Maximum Output Leve (10K ohms load):

≥ 4 V RMS

Subwoofer Time Align

0~18ms

Trouble Shooting

If you have problems operating this product, refer to this section. The most common problems are listed below, along with likely causes and solutions. If a solution to your problem cannot be found here, contact your dealer or the nearest authorised Pioneer service facility.

Problem		Correct action
General	No response from the unit.	<ul style="list-style-type: none"> Restart the unit by turning off the motorcycle for ten seconds, then turning the motorcycle back on.
	No sound from the unit.	<ul style="list-style-type: none"> The unit is muted. Adjust the volume. Select the correct audio source on the unit.
USB	Cannot play a media file.	<ul style="list-style-type: none"> The file format on the USB flash drive is not supported by the unit. Change media files. The file system of the USB flash drive is not supported by the unit. Change the USB drive.
Bluetooth	Cannot make Bluetooth streaming.	<ul style="list-style-type: none"> Make sure your mobile phone is within Bluetooth range. Pair and connect your mobile phone. CarPlay or Android Auto is being connected. Unplug your mobile phone from the unit to enable Bluetooth connection.
	Poor hands-free phone call quality.	<ul style="list-style-type: none"> Check signal strength on your mobile phone. Check that the microphone is firmly attached and plugged in. Or relocate the microphone for noise reduction.
	Cannot make Bluetooth connection.	<ul style="list-style-type: none"> CarPlay/Android Auto connection disables Bluetooth on the unit. Unplug CarPlay or Android Auto from the unit to enable Bluetooth connection. The unit is already connected to a mobile device. Disconnect the current Bluetooth connection before connecting to another Bluetooth device.
Apple CarPlay	<p>Connection failed.</p> <ul style="list-style-type: none"> -Communication failed and the system is trying to connect. -Wait for a while. Then, perform the actions below if the error message is still displayed. 	<ul style="list-style-type: none"> Restart the iPhone. Disconnect the cable from the iPhone, and then connect the iPhone again after a few seconds. Turn the ignition switch to OFF and then to ON.
Android Auto	<ul style="list-style-type: none"> Connect a USB cable to get started. Your phone does not support wireless, check your phone. 	<ul style="list-style-type: none"> Check if the device is compatible with Android Auto. Android Auto app is not installed on the device. Then install the app.
	<ul style="list-style-type: none"> Connection failed. Please check your phone to confirm connection. 	<ul style="list-style-type: none"> Wi-Fi connection failed and Android Auto app did not start. Check if the Wi-Fi function on the device is turned on.
	<ul style="list-style-type: none"> Android Auto has disconnected. 	<ul style="list-style-type: none"> Turn on the Wi-Fi function on the device and the unit when you use Android Auto.
FM/AM Radio	<ul style="list-style-type: none"> Poor radio reception. 	<ul style="list-style-type: none"> FM/AM antenna is not connected or extended. Connect and secure an FM/AM antenna (not included). The antenna output wire is not connected. Connect the wire. Turn off RDS/RBDS, TA and AF.

**SOUNDSTREAM RESERVE
LIMITED TWO-YEAR (2-YEAR) CONSUMER
WARRANTY WITH PURCHASE FROM AN
AUTHORIZED SOUNDSTREAM AND/OR
PRECISION POWER RETAILER.**

Epsilon Electronics Inc. promises to the original purchaser of this product to repair to like-new condition or replace this product with a new or like-new unit (at Epsilon Electronics' sole and absolute discretion), should it prove to be defective in workmanship or material under normal use, for a period of Two-years (2-years) from the date of purchase from a Soundstream and/or Precision Power authorized retailer. During this Two-year (2-year) period, there will be no service charge for repair or replacement.

This limited warranty extends only to the original purchaser of the product, and it is NOT transferable to the next owner or purchaser of the motorcycle into which the product was originally installed. This warranty does NOT cover labor costs for removal and re-installation of the product.

This warranty is void if the product has been damaged caused by installation or removal of the product and will not apply to any unit that is determined to have been modified or mis-used in a manner contrary to its intended purpose. This warranty is void if the product has been damaged by accident or unreasonable use, neglect, improper service or other causes not arising out of defects in material, construction, or workmanship. This warranty does not include the elimination of externally generated static or noise, or the correction of antenna problems or weak reception, damage to speakers, accessories, electrical systems, cosmetic damage or damage due to negligence, misuse, failure to follow operating instructions, accidental spills or customer applied cleaners, damage due to environmental causes such as floods, airborne fallout, chemicals, salt, hail, lightning or extreme temperatures, damage due to traffic accidents, road hazards, fire, theft, loss or vandalism, damage due to improper connection to equipment of another manufacturer or modification of existing equipment.

To file a warranty claim, please contact Soundstream's warranty office to obtain a Return Authorization number prior to shipping the product:

Phone: 1-800-724-1377
E-mail: repairs@soundstream.com
Website: soundstream.com/warranty

Epsilon Electronics Inc.
1550 South Maple Ave
Montebello, CA 90640 USA

After receiving the RA number, pack the product into suitable packaging, include dated proof of purchase, (i.e. a receipt or bill of sale) from the authorized retailer and a money order or cashier's check for return freight to Epsilon Electronics' corporate office, addressed above. Please clearly write the RA number on the outside of the packaging.

IN ORDER FOR THE TWO-YEAR WARRANTY TO BE VALID, YOUR UNIT MUST BE SHIPPED WITH PROOF OF INSTALLATION BY A SOUNDSTREAM OR PRECISION POWER AUTHORIZED SELLER. ALL UNITS RECEIVED BY SOUNDSTREAM FOR WARRANTY REPAIR WITHOUT PROOF OF SOUNDSTREAM OR PRECISION POWER AUTHORIZED DEALER PURCHASE AND INSTALLATION WILL BE COVERED BY THE LIMITED 1 YEAR WARRANTY. ANY PRODUCT RECEIVED BY SOUNDSTREAM FOR WARRANTY WITHOUT AN RA NUMBER AND PROOF OF PURCHASE FROM A SOUNDSTREAM AND/OR PRECISION POWER AUTHORIZED RETAILER WILL BE REFUSED. BY PURCHASING THIS PRODUCT, ALL WARRANTIES INCLUDING BUT NOT LIMITED TO EXPRESS WARRANTY, IMPLIED WARRANTY, WARRANTY OF MERCHANTABILITY, FITNESS FOR PARTICULAR PURPOSE, AND WARRANTY OF NON-INFRINGEMENT OF INTELLECTUAL PROPERTY ARE EXPRESSLY EXCLUDED TO THE MAXIMUM EXTENT ALLOWED BY LAW. SOUNDSTREAM NEITHER ASSUMES NOR AUTHORIZES ANY PERSON TO ASSUME FOR IT ANY LIABILITY IN CONNECTION WITH THE SALE OF THE PRODUCT. SOUNDSTREAM HAS ABSOLUTELY NO LIABILITY FOR ANY AND ALL ACTS OF THIRD PARTIES INCLUDING ITS AUTHORIZED RETAILERS OR INSTALLERS. BY PURCHASING THIS PRODUCT, THE CONSUMER AGREES AND CONSENTS THAT ALL DISPUTES BETWEEN THE CONSUMER AND SOUNDSTREAM SHALL BE RESOLVED IN ACCORDANCE WITH CALIFORNIA LAWS IN LOS ANGELES COUNTY, CALIFORNIA. Some states do not allow limitation on how long an implied warranty lasts. In such states, the limitation or exclusions of this Limited Warranty may not apply. Some states do not allow the exclusion or limitation of incidental or consequential damages. In such states, the exclusion or limitation of this Limited Warranty may not apply to you. This Limited Warranty gives you specific legal rights, and you may have other rights which vary from state to state.

FCC Notes

FCC Compliance

This device complies with Part 15 of the FCC Rules. Operation is subject to the following two conditions:

- (1) this device may not cause harmful interference, and
- (2) this device must accept any interference received, including interference that may cause undesired operation.

Warning: Changes or modifications to this unit not expressly approved by the party responsible for compliance could void the user's authority to operate the equipment.

Note: This equipment has been tested and found to comply with the limits for a Class B digital device, pursuant to Part 15 of the FCC Rules. These limits are designed to provide reasonable protection against harmful interference in a residential installation.

This equipment generates, uses and can radiate radio frequency energy and, if not installed and used in accordance with the instructions, may cause harmful interference to radio communications.

However, there is no guarantee that interference will not occur in a particular installation. If this equipment does cause harmful interference to radio or television reception, which can be determined by turning the equipment off and on, the user is encouraged to try to correct the interference by one or more of the following **measures:**

- Reorient or relocate the receiving antenna.
- Increase the separation between the equipment and receiver.
- Connect the equipment into an outlet on a circuit different from that to which the receiver is connected.
- Consult the dealer or an experienced radio/TV technician for help.

www.MotorcycleAudio.com

Follow Us on Social Media

