

RESERVE

by **SOUNDSTREAM**

Owner's Manual

EN

DEM UPGRADE HEAD UNIT FOR '98-'13 HARLEY-DAVIDSON® MOTORCYCLES



SOUNDSTREAM
TECHNOLOGIES

(SiriusXM)
READY

Bluetooth



WHDRG

Safety First	
Safety Definitions	2
Pre-Riding	
Check list	3
Care and cleaning	3
Screen	3
Appearance	3
Before Installation	4
Intallation	5
Panel Description	7
Wiring	8
Operation	
Main menu	11
Setting	11
Apple CarPlay/Android Auto	15
Radio operation	18
USB operation	18
Bluetooth Music	19
Bluetooth Phone	21
Camera in	21
SXM	21
Trouble Shooting	26
Warranty	27
FCC Notes	28

Safety Definitions

Statements in this manual preceded by following words are of special significance:

▲ WARNING

WARNING indicates a potentially hazardous situation which, if not avoided, could result in death or serious injury.

▲ WARNING

Set volume levels and other controls on audio and electronic devices before riding. Distractions can lead to loss of control, resulting in death or serious injury.

▲ WARNING

Do not select a volume level that blocks out traffic noise or interrupts the concentration necessary for the safe operation of the Motorcycle. Distractions or a volume level that blocks our traffic noise could cause loss of control resulting in death or severe injury.

Note

Pay attention while riding, keeping your eyes and clear mind on the road. Some features are locked out to prevent distraction, limited in capability while the Motorcycle is in motion. Even a part is available, donot allow it to distract you from operating your Motorcycle safely.

For safety, program the system when stopped. Perform system setup and get familiar with the controls and features of the infotainmentsystem before operating the Motorcycle on the road. This system cannot warn about the safety of an area, bad road conditions, and availability of emergency services.

Use this radio only in locations where it is safe to do.

Check list

Configure the system with your personal preferences before riding to use features and minimize distractions while on the road entirely.

1. Set brightness, background.
2. Configure presets.
3. Adjust audio settings like EQ, volume, fade, balance etc. before riding.
4. Pair, connect and set up phone features through Bluetooth.
5. Connect USB devices for Apple CarPlay® or Android Auto®.
6. Select station or media

CARE AND CLEANING

Use only **WHDRG** recommended products and methods to keep the radio, speakers, and other audio system components clean and in good condition.

Do not use any abrasives, polishes, or rubbing compoundsto clean the screen or other components. Do not use any ammonia-based cleaners on the net.

The use of other products or methods may cause damage to components.

Screen :

Do not use any chemical cleaners or chemical-containing wipes or cloths. These can cause damage to the screen surface.

Gently clean the display glasssurface with a clean, dry microfiber cloth. Before cleaning, it is suggested to remove any visible dust, dirt, sand particles with a gentle compressed airstream.

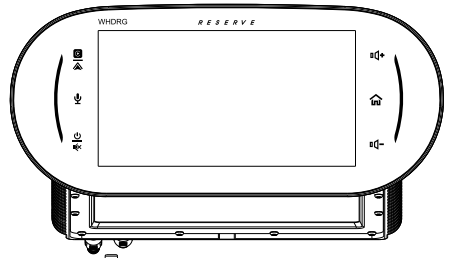

Front

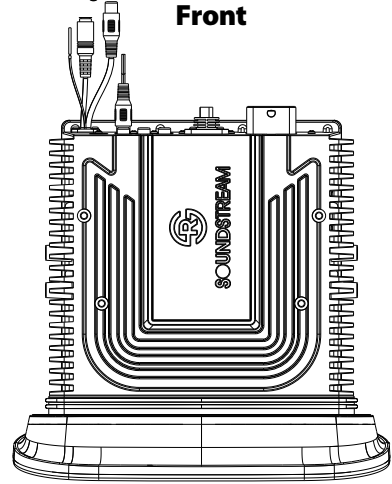

Top

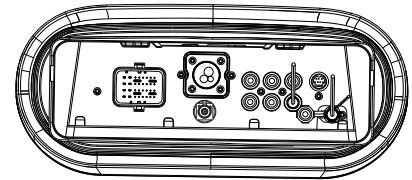

Back

Accessories and Installation

Harness Included!

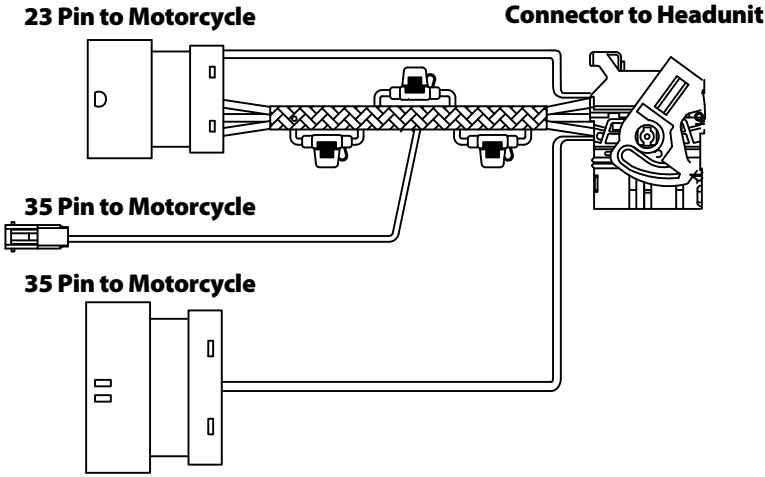

Installation Rubber Ring:

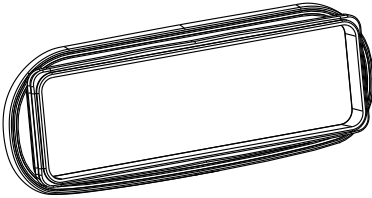

User Manual



Installation Screws (4pcs):



External Microphone:

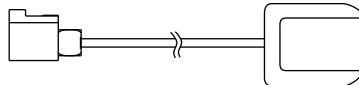
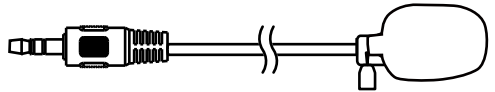

GPS Antenna

Installation

Removal of the Original Head Unit

To prevent accidental vehicle start-up, which could cause death or serious injury, remove main fuse before proceeding.

1. Remove each turn indicator by removing 2 bolts for each between the forks/handlebar & inner fairing wall. Use a 1/2" open-end/box-end wrench, ratcheting wrench, or short 1/2" socket and ratchet. The bolt might not unthread from the turn signal housing, however the acorn nut might instead. It will be easier to reinstall the indicator later if the bolt remains on the indicator housing. Set the bolts &/or acorn nuts aside and tuck the indicators aside.



Tip: Turn the handlebar/front wheel in the direction of the turn indicator you're working on to increase the work area, hopefully preventing bloody knuckles & scratched paint!

2. Remove six inner fairing bolts using a T25 Torx screw driver. Two screws are adjacent to the fuel & battery voltage gauges. Two more are located at the outside corner of each speaker grill. The last two screws are below each storage compartment hinge. Store these screws in the storage compartments for re-installation later.



Tip: Note the length of each screw set at the top, mid-section, and lower section as the lengths may differ.

3. While straddling the front wheel fender, grasp the outer fairing & gently pull it away from the inner fairing. With the fairing slightly pulled away from the bike, disconnect wire harness for the headlamp(s) and any other accessories. Lay the fairing on a protected flat surface to prevent damage.

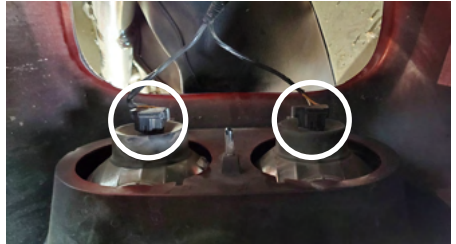

4. Disconnect all wire harnesses from the OEM radio. Use a pry tool, flat-head screwdriver, or pick tool to lift up on the locking tab, then pull the male connector out from the female connector. Also, unplug the FM antenna & disconnect the CB antenna (if equipped). If the OEM SiriusXM tuner is installed, disconnect & remove its antenna, it will not be used.



5. Remove the OEM head unit by removing 4 screws from the head unit support bracket. Use a 3/16" hex/allen key tool to remove 2 screws from each side. Set these four screws aside for reinstallation.



6. Gently pull the OEM radio out and up, away from the support bracket. No other parts from the OEM radio are needed.

7. Take a moment to clean the surfaces of the inner fairing surrounding the cutout for the radio & around the ovalized recess using a damp micro-fiber cloth. Any debris or residue left on these surfaces can affect the water-tight seal around WHDRG.

Installation of WHDRG Head Unit

1. Route the USB cable, antenna extension, GPS antenna, & RCA camera input w/ trigger into the cutout of the inner fairing. Firmly press WHDRG into the ovalized recess.

2. Secure WHDRG to the radio support bracket with the 4 screws set aside during removal of the original head unit (step 5) using the same hex/allan key tool.

3. Insert and lock the male OEM head unit wire harness connector to the female socket of the included wire harness. Then, insert and lock the male connector of the included wire harness into the corresponding female socket on the back of WHDRG. Swivel the latch into place, locking the male connector into the female receptacle.



4. Empty the contents of the storage compartment you wish to have the USB connector in. Drill a 1" hole in the middle/center of the storage compartment & liner using a 1" spade bit or step bit. Route the USB cable to the back of the storage compartment & into it. Firmly press the rubber grommet into place.

5. Connect the FM radio antenna to the female receptacle extension, and any accessory added to this installation: SiriusXM tuner, Bluetooth calling microphone, camera video-in & trigger, amplifier audio RCAs etc. The wire harness of WHDRG also includes a blue remote turn-on wire for amplifier(s).

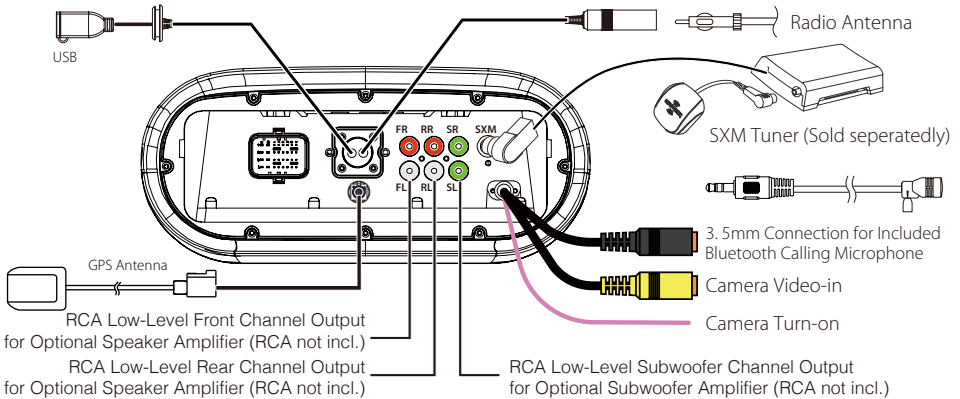

6. Take a moment to reinstall the main fuse if it was removed. At this point, WHDRG should turn-on. Verify all speakers are playing and the head unit is functioning. If successful, tie any loose wires that might impede reinstallation of the fairing.

7. Reassemble the outer fairing to the inner fairing by following the disassembly steps in reverse:
Connect headlight wire harnesses & close the fairings together
Reattach outer fairing to inner fairing using the six screws removed previously
Tuck turn indicator wiring inside the fairing, reattach the turn indicator acorn nuts/bolts

Panel description

Panel Control.

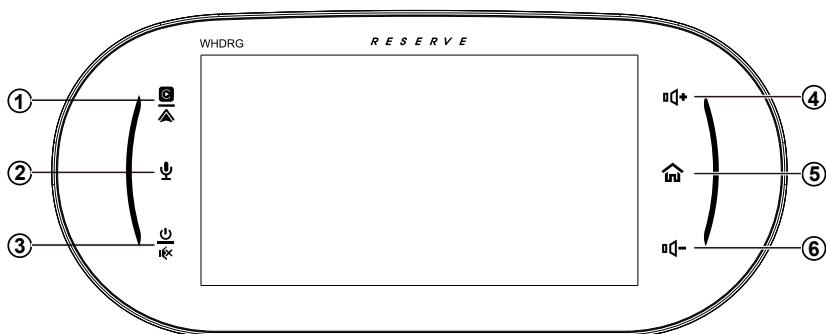

1 Apple CarPlay® / Android Auto®

Press to enter CarPlay® / Android Auto® directly(When the iPhone/Android phone is connected).

2 Siri Button (Voice Recognition)

When the iPhone/Android phone is connected, press **Siri** button to start the voice control function.

3 Power / Mute

- When the power is off, press to power on.
- When the unit is working, short pressing for Mute, press again for unmute.
- Pressing and hold to turn the source unit power off.

4 (Volume +)

- Press to increase the volume value.

5 Home button

- Press to toggle between Home screen and active media.
- Available selections: Radio, SiriusXM, Apple CarPlay®/Android Auto®, BT Music, BT Phone, USB,Settings, Camera in.

6 (Volume -)

- Press to decrease the volume value.

Handle Bar Control.

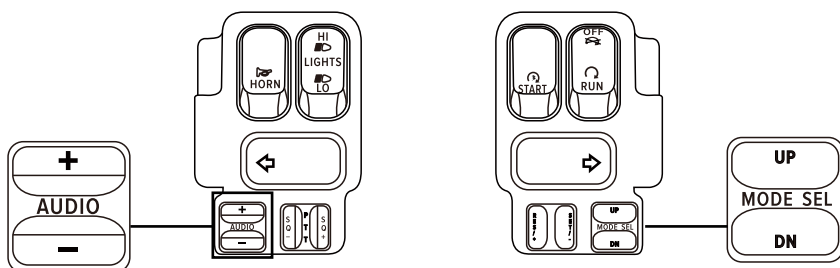

- +** • Press to increase the volume value.



AUDIO

Mute Button

- When the unit is working, short pressing for Mute, press again for unmute.

Siri Button (Voice Recognition)

- When the iPhone/Android phone is connected, Long press **this** button to start the voice control function.

- • Press to decrease the volume value.

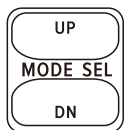

MODE SEL

- UP** **[Radio]** Press to select Next preset radio station for broadcasting. Press and hold to seek upward.

- [USB Music]** Press repeatedly to shift track next for playback.

- Press and hold to active various fast forward speeds for playback.

- [Bluetooth Music]** Press repeatedly to shift track next for playback.

Mode Button

- When the unit is working, press to select desired playback mode.

Bluetooth Button (Bluetooth Connected)

- When incoming call, short press to answer the call, long press to reject the call.

- When talking call, long press to hangup.

- DN** **[Radio]** Press to select previous preset radio station for broadcasting. Press and hold to seek downward.

- [USB Music]** Press repeatedly to shift track previous for playback. Press and hold to active various fast rewind speeds for playback.

- [Bluetooth Music]** Press repeatedly to shift track previous for playback.

Wiring

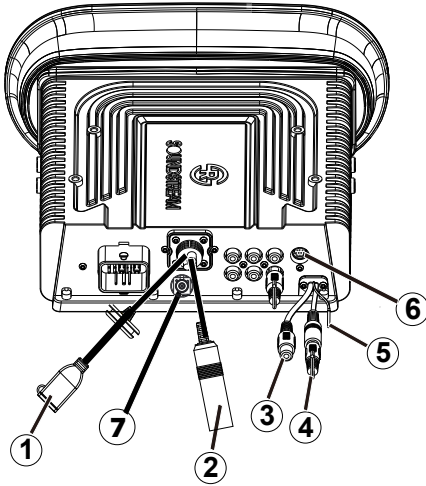

1 USB Connector

Connect the external USB cable for USB device, Android smart phone, iPhone.

2 Radio Connector

Connect the Radio Antenna from motorcycle.

3 Camera in

Connect the Camera in.

4 External Microphone Connector

Connect the external Microphone cable.

5 Camera +12 V DC (Max 0.5A)

Connect the Camera power cable.

6 SiriusXM Tuner Connector

Connect the SXV300 tuner.

Note: SiriusXM SXV300 Tuner sold separately, SiriusXM subscription required.

7 GPS Antenna Connector

Connect the GPS connector.

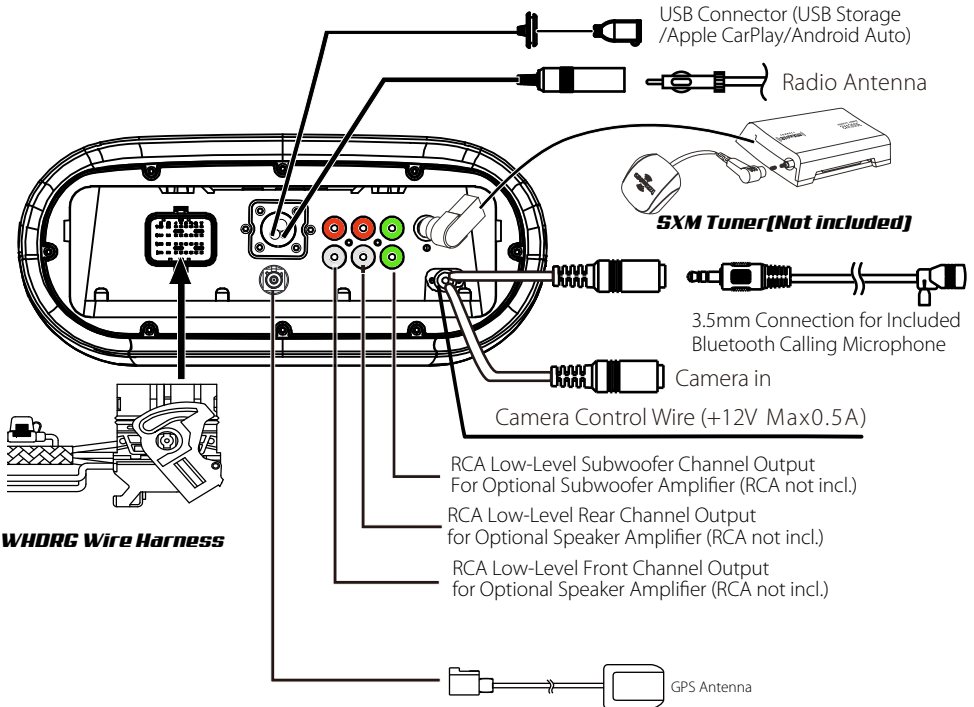

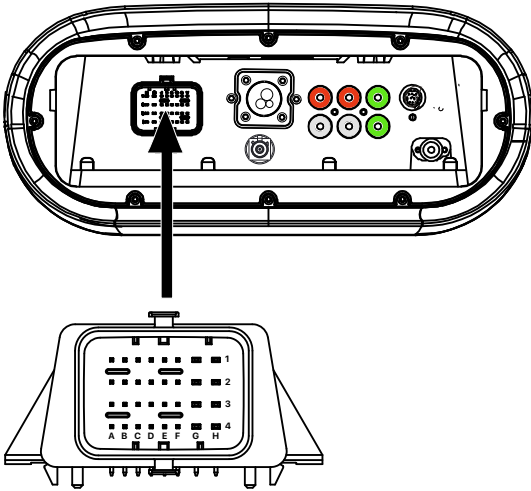

32 Pin Connector Pin Definition:

			D1, Green/Black(RL-)
			D2, Red(ACC)
A3, Blue(SWC R2)			
A4, Blue(SWC C1)	B4, Blue(SWC C0)	C4, Blue(SWC C2)	D4, Blue(SWC C4)
E1, Green(RL+)	F1, Purple/Black(RR-)	G1, White/Black(FL-)	H1, Gray/Black(FR-)
	F2, Purple(RR+)	G2, White(FL+)	H2, Gray(FR+)
E3, Blue(REM)		G3, Black(Ground)	H3, Yellow(B+)
E4, Blue(SWC R0)	F4, Blue(SWC R1)	G4, Black(Ground)	H4, Yellow(B+)

Main Menu



WHDRG is a headunit for Motorcycle with the following functions:





Wireless / Wired Apple CarPlay®, Wireless / Wired Android Auto®, Radio, USB, BTMusic, Phone, SiriusXM ready, Camera.

Touch the corresponding Mode icon to enter playing mode. The Mode icon in gray means the corresponding function is not ready, or the proper device has not been connected.



Hidden soft button bar:

A hidden pop up soft button bar is located at the bottom. Touch the icon  to shown the soft button bar. Touch the  to hidden.

-  Dimming, to change Daylight or Night.
-  EQ, to enter the Equalizer setting menu.
-  Hidden, to hide the bottom buttons.
-  Setup, to enter the Settings Menu.
-  Device List, to enter the device list page.

Touch the  icon to enter the Setup menu.

The Setup menu is included **System Settings, Audio & EQ Settings, Display Settings, Bluetooth Settings.**

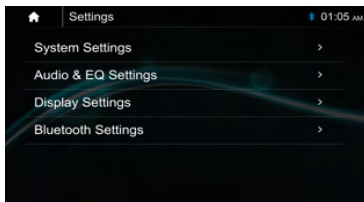

Settings

System Settings:

The **System Settings** allow the user to set up the **Language, Date & Time, Key Beep, GPS Status, Factory Reset** and **About**.

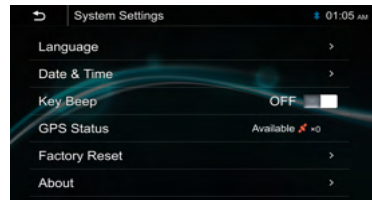

Language:

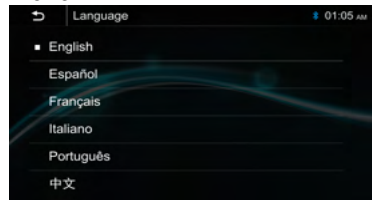

Date & Time:

To setting Time format (12H or 24H), setting the date and time

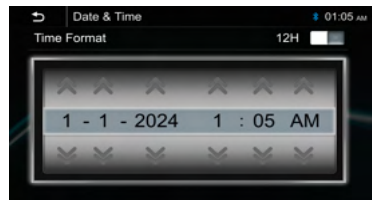

GPS Status:

Show the current available GPS satellite quantity.

Key Beep: On / Off

To set the touch button beep tone is On or Off.

Factory Setting:

To default the default factory settings:



Tap "OK" to reboot the headunit.

Settings

About:

To display the WHDSG MCEU, SOC, hardware and firmware version, and the headunit's serial number.



How to Update:

1. Download the newest Firmware Update and Save to Computer. After downloading, make sure the compressed-files are unzipped and are copied onto a blank USB Flash Drive (**64GB Max**) on the Root Directory File of USB Flash Drive.
2. Insert USB stick and select the "Settings Icon" from the Home Screen.
3. Select "System Settings" Tab at top, then next screen select "About" button.
4. Select "Update" and on next screen, select "Update" Again.
5. ((Wait for both Updates to complete)) Headunit will restart itself once both updates are complete. New Firmware Info:xxx

Note:

Use a good quality flash drive to successfully execute this update.

Not all USB flash drives are the same.

Use a flash drive with Type-A connector.

The USB port Harley Davidson built into your bike is Type-A. Your flash drive needs to be Type-A also.

Flash drives with USB Type-C connectors, Type-C to Type-A adapter cables, etc. should not be used.

Although more convenient, they increase the chances of corruption or failed data transfer.

Format your flash drive before saving the update.

Before downloading the update to your flash drive, format it using FAT32 file format. This can be done by the disk drive tools of your PC/iOS computer. Be sure to copy any files previously saved on the flash drive before formatting as this process will erase any files previously saved. This fresh formatting of your flash drive will reduce the chances of data corruption or errors when saving & uploading the update.

Use a good quality flash drive from a reputable manufacturer.

Various flash drives you might have gotten as a freebie from a vendor at a rally, part of a novelty key chain/toy, from a \$1 container at your local convenience store, etc. These tend to be poorer quality, have slower data transfer rates, and are more likely to crash during downloading or uploading. If the data transfer to your HDHU fails during the process, it is possible the computer inside your HDHU will become corrupt, and it may not be recoverable.

Audio & EQ Setting

Below shown is the Audio setting Menu.



Balance/Fader:

Touch the + or - of Balance/Fade to tune for the driver and passenger preference.

The value of **Balance (Left 12 - Right 12)** and **Fader (Front 12 - Rear 12)**.

Touch **Reset** to set both **Balance** and **Fader** to **0**.



13-Band Equalizer:

13-band of EQ tuning, slide the **EQ** bar to tune each band frequency level according to user preference.

Touch **Reset** button to set all Band to **zero**.

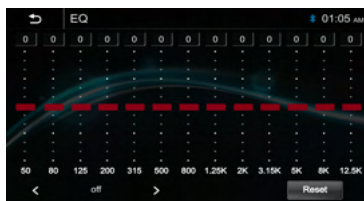

Touch "<" or ">" to select the preset equalizer: **Rock > Pop > Electric > Jazz > EQ Custom > off**.

About the Crossover

This unit is equipped with an active crossover. The crossover limits the frequencies delivered to the outputs.

The crossover adjusts the HPF (high pass filter) or LPF (low pass filter) of speakers and subwoofer, and also the slope (how fast the filter rolls off the highs or lows).

Adjustments should be made according to the reproduction characteristics of the speakers. Depending on the speakers, a passive network may not be necessary. If you are unsure about this point, please consult your authorized Alpine dealer.

- **HPF (high pass filter):** Cuts the lower frequencies and allows the higher frequencies to pass.
- **LPF (low pass filter):** Cuts the higher frequencies and allows the lower frequencies to pass.
- **Slope:** The level change (in dB) for a frequency change.
- The higher the slope value, the steeper the slope becomes.
- Do not use a tweeter without the HPF set on, with a high cut-off frequency, otherwise damage may occur to the speaker due to the low frequency content.
- **Adjustment** should be made according to the recommended crossover frequency of the connected speakers. Determine the recommended crossover frequency of the speakers. Adjusting to a frequency range outside that recommended may cause damage to the speakers.

For the recommended crossover frequencies of speakers, refer to the respective Owner's Manual. We are not responsible for damage or malfunction of speakers caused by using the crossover outside the recommended value.

Front/ Rear Crossover:

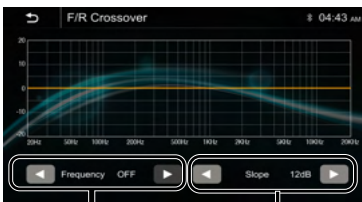

Slope: 12dB / 24dB

User can touch "<" or ">" to select the desired frequency Value.

Subwoofer Settings:



- Subwoofer Output:** ON or OFF.
- Subwoofer Level:** -10~+10
- Subwoofer Crossovers:**
- Subwoofer Phase:** 0° or 180°.

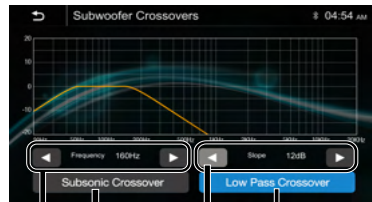

Set Low Pass Crossover Frequency & Slope.

Slope: 12dB / 24dB

Set Subsonic Crossover Frequency.

User can touch "<" or ">" to select the desired frequency Value.

AMP Turn-on Delay: ON /OFF.

User can set **AMP Turn-on Delay** is ON or OFF.

Volume setting:

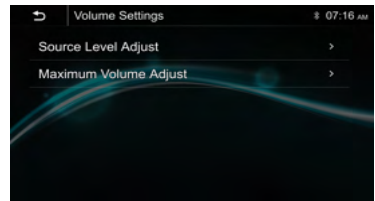

Source Level Adjust:

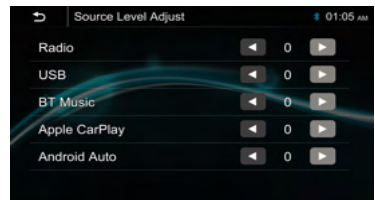

User can adjust the source mode (**Radio, USB, BT Audio, Apple CarPlay, Android Auto**) gain value. The gain can be adjusted from -5~+5 seperately.

Settings

Maximum Volume Adjust:



User can select Maximum Volume is On / Off. When select ON, user can set the desired Maximum Volume level.

Display setting:

Below is the Display setting menu, user can select *Nighttime Brightness, Touch Key Color, Background Wallpaper*.

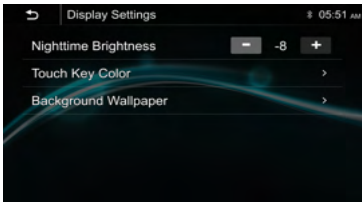

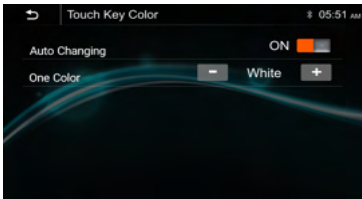

Nighttime Brightness : -8 – 0. (Default is 0).

Touch Key Color



LED Auto(Changing Color) : On/Off.

ON: The Led color will change automatically.

OFF: You press the button  or  to select desired color.

Color: White / Red / Orange / Yellow /Blue / Green / Purple / Cyan.

Background Wallpaper:

User can select the preset wallpaper or select prefer picture in USB driver as the wallpaper.



Touch the corresponding picture to select the prefer background.

Touch "+", the head unit will search the USB photo file for wallpaper.

Select a picture and touch OK to add the wallpaper.

 Select another picture for replacing the current wallpaper.

Bluetooth Settings:

Touch the Bluetooth Settings from the setting menu will be shown below:



Bluetooth: On/Off (Select Bluetooth connection is On or Off).

Pairing: To start the pairing.



BT Address : Shown headunit BT Address.

Device Name : WHDRG .

Clear Records: To clear the device list records.

Apple CarPlay® & Android Auto®

Apple CarPlay :

You can operate iPhone applications with finger gestures such as tapping, dragging, scrolling, or flicking on the screen of this product.

Compatible iPhone models

For details about compatibility of iPhone models, refer to the following website.
<https://www.apple.com/ios/carplay>

WARNING

Certain uses of the iPhone may not be legal while driving in your jurisdiction, so you must be aware of and obey any such restrictions. If in doubt as to a particular function, only perform it while the car is parked. No feature should be used unless it is safe to do so under the driving conditions you are experiencing.

Notes on using Apple CarPlay

- iPhone with iOS 7.1 or later is required. Update to the latest iOS version before use.
- Apple CarPlay can be used on iPhone 5 or later.
- For details on compatible models, refer to the compatibility list on the support site on the back cover.
- For details about Apple CarPlay, refer to the manual supplied with your iPhone, or visit the website of Apple CarPlay.
- Since the GPS on your iPhone is used, place your iPhone where it can easily receive a GPS signal
- You can use Siri function by touching  button once Apple CarPlay is activated
- The Bluetooth connection with the Apple CarPlay compatible device will be terminated automatically if Apple CarPlay is turned on.
- Hands-free phoning via Bluetooth wireless technology is not available while Apple CarPlay is on.

Starting procedure of using Apple CarPlay

- 1 Connect an Apple CarPlay compatible device to this unit via USB.
- 2 Touch the Apple CarPlay icon.
The Apple CarPlay home screen appears.

You can use Apps of connected iPhone. The items displayed and the language used on the screen differ among the connected devices.
To enter the Apple CarPlay mode, touch Apple Carplay icon on the Home selection screen.



① Application keys

Start the application.

②

Display the home screen of Apple CarPlay. Touch and hold to activate Siri.

③ Home

Exit the Apple CarPlay screen and displays Home screen.

* The icon design may change depending on the iOS version.

How to connect Wireless Apple CarPlay

Starting procedure of using Wirelessly Apple CarPlay

Before using Apple CarPlay wirelessly, turn on the Bluetooth function on the iPhone.

1 On the Main menu tap the  icon access to Device Link interface.

Show below pop-up menu, tap **YES** start to search the available devices.

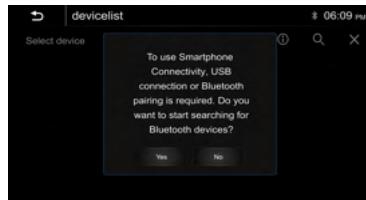

Below pop-up menu will be shown:

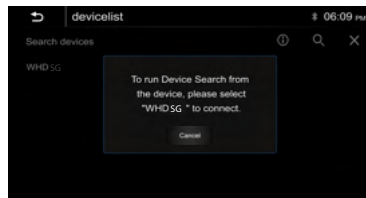

The user use the iPhone search the device via Bluetooth, then follow the pop notice step by step to connect

1. Turn on your iPhone's Bluetooth and Wi-Fi, and connect to WHDSG.

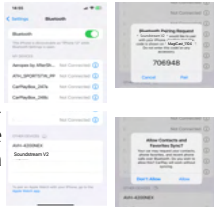

a. Go to Settings > Bluetooth and the phone should be able to find a Bluetooth Device(WHDSG).

b. A Bluetooth Pairing Request will be displayed on the screen with a specific code which should match what is shown on. Tag "Pair" for connecting.

c. Immediately following the Pairing notification, a new request to "Allow Contacts and favorites Sync" on your iPhone, Allow in order to have caller ID and access to your contacts through CarPlay.

Note: Following the BT connection, there is no need to try and connect WIFI manually (although it does need to be ON), after the BT connection process is complete, the WIFI will connect automatically on its own.

3.Wait for a moment for CarPlay connection, click use CarPlay and enter the UI interface.

4. iPhone will pop-up prompts, click "Use CarPlay".



2. When the headunit detect the available device, follow the pop-up notice step by step to connect the iPhone. After connected, will show below page:

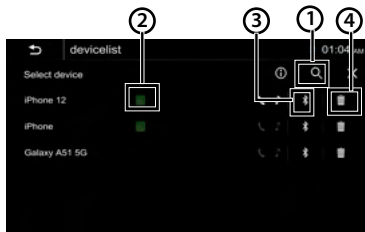

1. Tap to start to search new device.
2. Tap to access Apple CarPlay interface.
3. Tap to access Bluetooth interface.
4. Tap to delete current device.

Android Auto®:

You can operate Android applications with finger gestures such as tapping, dragging, scrolling, or flicking on the screen of this product

Starting procedure of using Android Auto

- 1 Connect an Android Auto™ compatible device to this unit via USB.
 - 2 Touch the Android Auto icon.
- The Android Auto home screen appears

Note: You can use Voice function by touching  button once Android Auto is activated.

- The Bluetooth connection with the Android Auto compatible device will be terminated automatically if Android Auto is turned on.
- Hands-free phoning via Bluetooth wireless technology is not available while Android Auto is on.

Notes on using Android Auto

- Android phone with Android 5.0 or higher is required. Update to the latest OS version before use.
- Your Android phone needs to support Android Auto. For details on compatible models, refer to the compatibility list on the support site on the back cover.
- Download the Android Auto app on Google Play.
- For details about Android Auto, refer to the manual supplied with your Android phone, or visit
- Since the GPS on your Android phone is used, place your Android phone where it can easily receive a GPS signal.
- Android Auto may not be available in your country or region.the website of Android Auto.

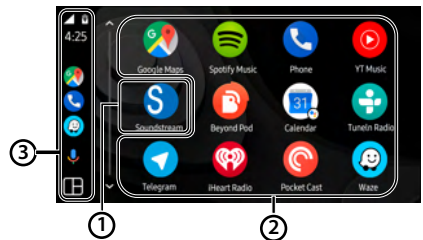

① Application keys

Start the application.

② Home

Exit the Android Auto screen and displays Home screen.

③ Operation Bar

Starts the application or displays information.

Apple CarPlay® & Android Auto®

How to connect Wireless Android Auto Starting procedure of using Wirelessly Android Auto

1 On the Main menu tap the  icon access to Device Link interface.

Show below pop-up menu, tap **YES** start to search the available devices.

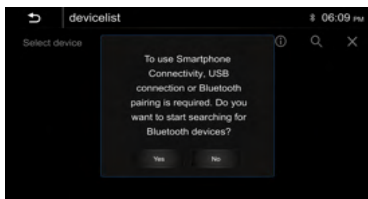

Below pop-up menu will be shown:

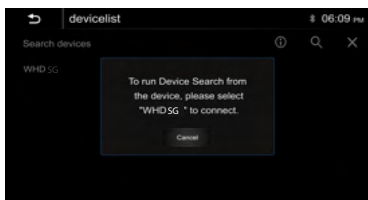

When the headunit detect the available device, follow the pop-up notice step by step to connect the iPhone. After connected, will show below page:

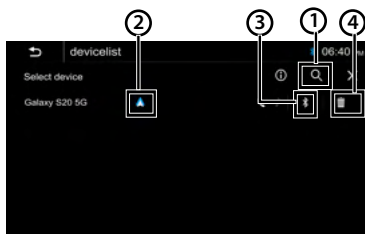

1. Tap to start to search new device.
2. Tap to activate Android Auto interface.
3. Tap to activate Bluetooth interface.
4. Tap to delete current device.

Note: Following the BT connection, there is no need to try and connect WIFI manually (although it does need to be ON), after the BT connection process is complete, the WIFI will connect automatically on its own.

- 3.Wait for a moment for Android Auto connection, click use Android Auto and enter the UI interface.
4. Android Phone will pop-up prompts, click "Use Android Auto".

The user also can use the Android Smartphone search the device via Bluetooth , then follow the pop notice step by step to connect wireless Android Auto.

1. Turn on your phone's Bluetooth and Wi-Fi, and connect to WHDSG.

a. Go to Settings > Bluetooth and the phone should be able to find a Bluetooth Device(WHDSG) .

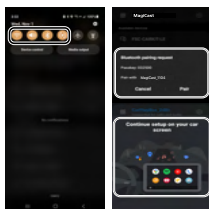

b. A Bluetooth Pairing Request will be displayed on the screen with a specific code which should match what is shown on. Tag "Pair" for connecting.

c. Immediately following the Pairing notification, a new request to "Allow Contacts and favorites Sync" on your Android smartphone, Allow in order to have caller ID and access to your contacts through Android Auto.

Touch "Radio" in the main menu to enter the radio interface.

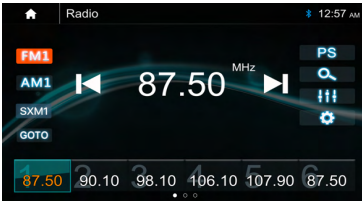

- FM1** Touch "FM" can change between FM1>FM2>FM3.
- AM1** Touch "AM" can change between AM1>AM2.
- SXM1** Touch "SXM" can change between SXM1>SXM2>SXM3.
- GOTO** Touch "GOTO" then Pop-up the GOTO menu and enter the desired Frequency Number.

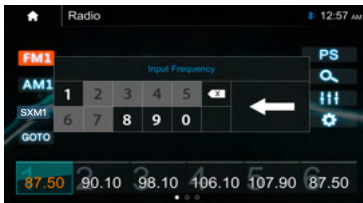

- PS** Touch for Prescan search, each scanned station will be played for 10 sec, touch again to stop. Touch to auto scan searching.
- Q** Touch to enter EQ settings.
- ⚙** Touch to enter Radio settings.
- ⏪** Short touch to seek down, long touch to tune down.
- ⏩** Short touch to seek up, long touch to tune up.

Preset channel, six preset buttons store and recall stations for each band. Touch and slide the preset channel can switch to next band FM1/FM2/FM3 or AM1/AM2.

Store a Station

1. Tune radio to desired station.
2. Touch and hold the one of the preset station for more than 3 seconds, then the preset button will be highlighted on the screen, and the preset station will be stored.

Radio setting:



Radio Area: Select the region, America/Europe /Eastern Europe /Japan /Southeast Asia /Latin America/ Asia / Australia.

RDS: Switch ON or OFF.

TA: Switch ON or OFF.

AF: Switch ON or OFF.

PTY: Enter PTY list.

Note: AF is only for Europe region.

PTY Information:





USB

Plug the USB; the USB icon will be colorful. Touch the USB icon to enter the USB playback mode. The source unit will playback the audio in the USB device.









- +** Press to go to the following folder.
- 📁** Press to search Audio/Image files.
- ⏪** Press to go to the previous folder.
- ⏮** Short press to skip previous track. Long press to fast reverse.
- ⏸** Play or Pause button.
- ⏭** Short press to skip next track. Long press to fast forward.

USB

-  Press to select Repeat All> Repeat 1> Repeat Folder.
-  Press to switch Random is On or Off.
-  Press to select Audio setting or set the preferred EQ of each band in custom mode.

Picture Playback





-  Press to search Audio/Image files.
-  Press to repeat playback all the pictures.
-  Press to browse previous picture.
-  Play or Pause button.
-  Press to browse next picture.
-  Press to rotate 90 degree anticlockwise.
-  Press to rotate 90 degree clockwise.

File List Browsing

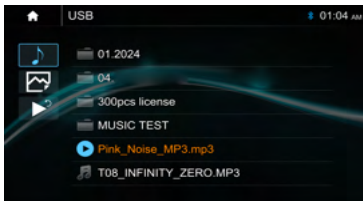
Touch  to browse the folder and file list of the USB device.







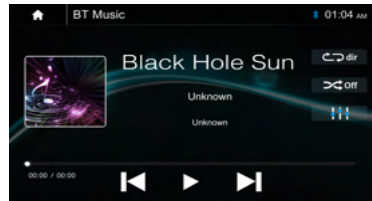

-  Select Audio or Music files.
-  Select Picture files.
-  Return to playing previous file.

Bluetooth Music

Bluetooth Music:

Touch the BT Music icon to enter Bluetooth Music playing mode. If the Bluetooth is connected, the music will be playing as below shown:



-  Short press to skip previous track.
-  Play or Pause button.
-  Short press to skip next track.
-  Press to select Repeat All> Repeat 1> Repeat Folder.
-  Press to switch Random is On or Off.
-  Press to select the preferred EQ of each band in custom mode.

Bluetooth Connect:

If the Bluetooth is not connected, press Reconnect the paired Phone or pairing to pair the new device.



Bluetooth Pairing:

Pairing screen will be shown as below:

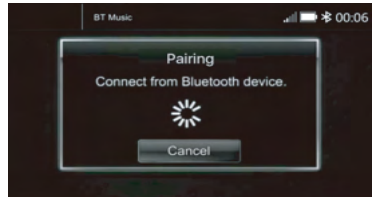

Turn on the Bluetooth of the Mobile phone/ Bluetooth device; you can see the "WHDRG." Select the "WHDRG" for pairing and connection.







Bluetooth Phone

Bluetooth Phone:





After the mobile Phone is connected with the source unit via **Bluetooth(HFP)**, the user can go through the source unit.

Make a phone call. Touch the Phone icon in Main Menu to go to BT Phone mode. Please note it needs to connect the microphone for phone calls.





-  Keypad. Tap it to enter call mode.
-  History. Tap it to show the call record, missed, received and dialed calls.
-  Contact. Tap it to show the phonebook of connected device.
-  BT Setup. Tap it to set Auto answer and Microphone gain.
-  Make a call or Accept the incoming call.
-  Backspace, tap it to clear the incorrect dial digit.

Make a Call:

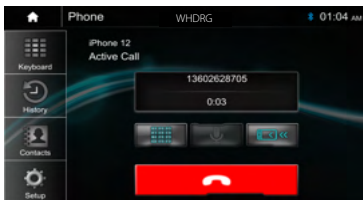
1. Touch the  icon to enter dial screen.
2. Using the keypad , touch 0-9,*,# , enter the desired number to dial. If you input an incorrect number, touch the  icon on the keypad to delete the incorrect number.
3. Once the correct number appears on the screen, touch the  icon to go to dialing interface.
4. To end the call, touch the icon  on the screen.



-  Interchange between phone and source unit.
-  ON / OFF the Microphone function.
-  Display the Keypad.

Receive an incoming call:

If the Phone is connected with the source unit via Bluetooth, when an incoming call, below screen will be shown:

Press  to answer the incoming call.

Press  to reject the incoming call.



History:

Touch the  icon to display the call combined list.

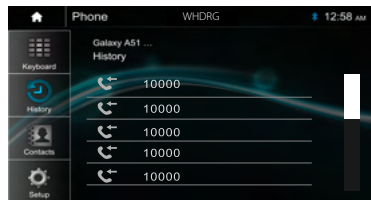

Slide the bar at the right up and down to display a call logs.

Contacts:

Touch the icon  to access the phone book of the connected mobile Phone.

To make a call from the phonebook, simply touch the contact's name

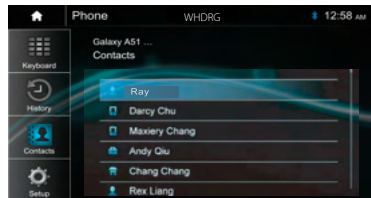

BT Setup:

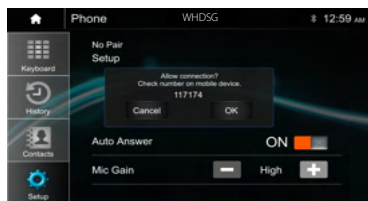

Auto Answer On/Off, incoming call auto answer.

MIC Gain: Low /Middle /High

Camera View

For connecting a camera.

Displaying the picture from the Camera

The camera view screen is displayed when you enter the Camra in.



SiriusXM Ready

SiriusXM is where moments happen. The widest, deepest variety of music, ad-free. More games, more sports, more coverage than anywhere. The most extensive entertainment, complete news coverage and every kind of comedy. Listen in your car, on your phone, online and at home. A SiriusXM Vehicle Tuner and subscription are required. For more information, visit www.siriusxm.com.

Activating your SiriusXM Subscription after installing your SiriusXM Connect Vehicle Tuner and antenna, power on your Headunit and select SiriusXM mode. You should be able to hear the SiriusXM preview channel on Channel 1. If you cannot hear the preview channel, please check the installation instructions to make sure your SiriusXM Connect tuner is properly installed.

After you can hear the preview channel, tune to **Channel 0** to find the **Radio ID** of your tuner. In addition, the Radio ID is located on the bottom of the SiriusXM Connect Vehicle Tuner and its packaging. You will need this number to activate your subscription. Write the number down for reference.

Note: the SiriusXM Radio ID does not include the letters I, O, S or F.

In the **USA**, you can activate online or by calling SiriusXM Listener care:

- Visit www.siriusxm.com/activatenow
- Call SiriusXM Listener Care at **1-866-635-2349**

For **Canadian** Subscriptions, please contact:

- Visit www.siriusxm.ca/activate
- Call SiriusXM Customer Care at **1-888-539-7474**

As part of the activation process, the SiriusXM satellites will send an activation message to your tuner. When your radio detects that the tuner has received the activation message, your radio will display "Subscription Updated".

Once subscribed, you can tune to channels in your subscription plan. Note, the activation process usually takes 10 to 15 minutes, but may take up to an hour. Your radio will need to be powered on and receiving the SiriusXM signal to receive the activation message.

To enter SiriusXM mode, touch the SXM icon on the Main Menu:

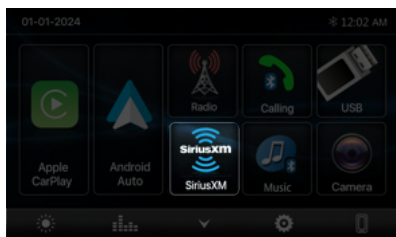

SiriusXM Operation

If the **CHECK TUNER** message appears, verify all connections are complete. Confirm the Vehicle Connect Tuner is connected, as well as the antenna for the Vehicle Connect Tuner.











When successfully connected, the user interface will appear:



SiriusXM Channel Logos are displayed in the user interface, providing a graphical representation of the current channel tuned. Album art can be displayed for most of the SiriusXM music channels. When album art is not available, the channel logo or the SiriusXM logo will be displayed.

Note: Compatible with SXV200 or later tuner models. Not all music channels contain album art images.

User Interface Operation

-  Press FM or AM keys to toggle between SXM & FM/AM radio mode
-  Press the SXM key to toggle between three preset groups
-  Press the ALRT key to view current song and/or artist alerts
-  Press the Channel Browse key to scroll channel listings by category
-  Press the Direct Tune key to enter a specific channel number to tune
-  Press the EQ key to open the 10-band equalizer settings
-  Press the Settings icon to access settings specific for SiriusXM mode
-  Press the Next or previous channel keys to advance channels
-  Press any preset key to tune the stored channel. To store a preset, tune to the desired channel, then press & hold on the preset location for 3 seconds.

Artist & Song Alerts **ALRT**

While listening to SiriusXM Satellite Radio, you can mark Artists and/or Songs for which you wish to be alerted. The radio will display an Alert message when a matching artist or song is found on another channel. Then you can choose if you want to tune to that favorite or you can ignore the alert and stay on your current channel. To save an artist or song title, press on the artist name or song title on the screen. Then, confirm again to save the favorite.

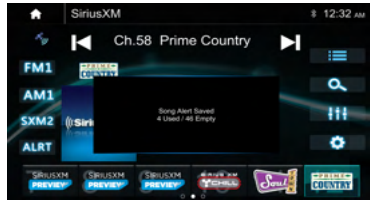
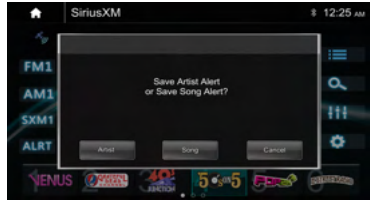

Channel Browse

Press the Browse key to scroll channel listings by category or all available channels.

Channel List

Press **Ch. List** to view all available channels in numeric sequence. Scroll the list to the desired channel, then select within the channel row to tune the channel.



Category List

Press **Cat. List** to view all available channels in category sequence.



Select a category by pressing the left or right arrows above the channel list. Scroll the corresponding category's channels below, press a channel name to tune the channel.

Info

At any time, press the content key on the right side to view the **Artist, Song, Info, Category, Channel** information about the song/content currently playing on the channel(s) listed.

Favorite

Press the **Favorite** key to view all stored artist & song title alerts. Press the **X** at right of any undesired alerts to delete it. Temporarily disable any alert by deselecting the check box **Som** left of any alert. Disable all alerts by sliding the switch on top to off.



Direct Tuning a Channel

Press the Direct Tune key to enter a channel number to tune. Enter the channel number using the keypad pop-up, then select the green check box **✓** to confirm your selection. If a number is entered in error, press the red backspace **⬅** key to erase the last digit.



SiriusXM Settings Menu

Press the settings icon to enter the SiriusXM settings menu.

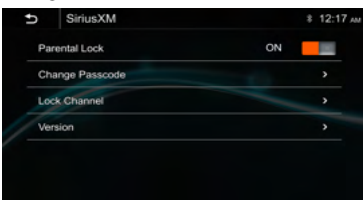

Parental Controls

The Parental Lock feature can be used to block user selected channels from playback. To enable the parental lock, slide the virtual switch to ON. The switch should illuminate orange. A passcode pop-up will appear, requesting the parental lock passcode. Enter the 4-digit passcode, then select the green check **✓** box to confirm. If a number is entered by mistake, press the red backspace **⬅** key to erase the last digit. The default passcode is 0000.

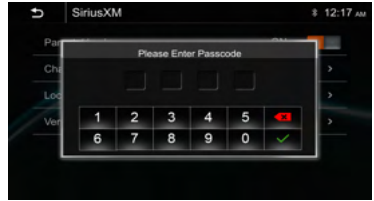

Then, the channel list will appear to scroll the subscribed channels. Select any channel(s) to lock. When a channel is successfully locked, a lock icon will appear adjacent to the channel name.



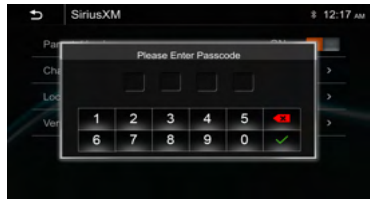

Change Passcode

Select Change Passcode to change the passcode required to activate the parental lock feature and to lock & unlock channels. A passcode pop-up will appear, requesting the current passcode. Enter the 4-digit passcode, then select the green check box **✓** to confirm. If a number is entered by mistake, press the red backspace key **⬅** to erase the last digit. The default passcode is 0000.

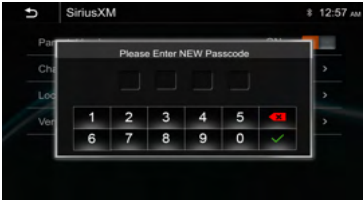

Then, another passcode pop-up will appear, requesting the new passcode. Enter the 4-digit passcode, then select the green check box **✓** to confirm. If a number is entered by mistake, press the red backspace key **⬅** to erase the last digit.



Then, a third & final passcode pop-up will appear, requesting to enter the new passcode again to the green check box  to confirm. If a number is entered by mistake, press the red backspace key  to erase the last digit.

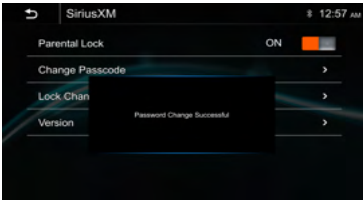

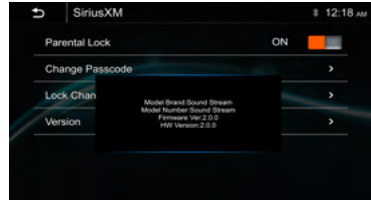

Version

Show the model's brand information:



Lock Channel

Select Lock Channel to lock or unlock channels from playback. A passcode pop-up will appear, requesting the current passcode. Enter the 4-digit passcode, then select the green check box  to confirm. If a number is entered by mistake, press the red backspace key  to erase the last digit. The default passcode is 0000.

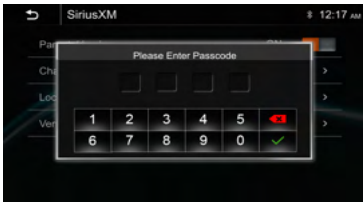

Then, the channel list will appear to scroll the subscribed channels. Select any channel(s) to lock or unlock. If a channel is successfully locked, a lock icon will appear adjacent to the channel name.



SiriusXM trouble shooting

Advisory Message	Cause	Explanation / Solution
Check Antenna	The radio has detected a fault with the SiriusXM antenna. The antenna cable maybe either disconnected or damaged.	<ul style="list-style-type: none"> -Verify that the antenna cable is connected to the SiriusXM Connect Vehicle Tuner. -Inspect the antenna cable for damage and kinks. Replace the antenna if the cable is damaged. -SiriusXM products are available at your local car audio retailer or online at: shop.siriusxm.com/all-parts/
Check Tuner	The radio has difficulty communicating with the SiriusXM Connect Vehicle Tuner. The tuner may be disconnected or damaged.	Verify that the SiriusXM Connect Vehicle Tuner cable is securely connected to the radio
No Signal	The SiriusXM Connect Vehicle Tuner has difficulty receiving the SiriusXM satellite signal.	<ul style="list-style-type: none"> -Verify that your vehicle is outdoors with a clear view of the sky. -Verify that the SiriusXM magnetic mount antenna is mounted on a metal surface on the outside of the vehicle. -Move the SiriusXM antenna away from any obstructions. Inspect the antenna cable for damage and kinks. -Consult the SiriusXM Connect Vehicle tuner installation manual for more information on antenna installation. Replace the antenna if the cable is damaged. SiriusXM products are available at your local car audio retailer or online at shop.siriusxm.com/all-parts/
Subscription Updated	The radio has detected a change in your SiriusXM subscription status.	<ul style="list-style-type: none"> -Press OK to clear the message. -In the U.S.A., visit www.siriusxm.com or call 1-866-635-2349 if you have questions about your subscription. -In Canada, visit www.siriusxm.ca/activate or call CustomerCare at 1-888-539-7474 if you have questions about your subscription. shop.siriusxm.com/all-parts/
Channel Unavailable	The channel that you have requested is not a valid SiriusXM channel or the channel that you were listening to is no longer available. You may also see this message briefly when first connecting a new SiriusXM Connect Vehicle tuner.	Visit www.siriusxm.com for more information about the SiriusXM channel lineup.
Channel Unsubscribed	The channel that you have requested is not included in your SiriusXM subscription package or the channel that you were listening to is no longer included in your SiriusXM subscription package.	<ul style="list-style-type: none"> -In the U.S.A., visit www.siriusxm.com or call 1-866-635-2349 if you have questions about your subscription. -In Canada, visit www.siriusxm.ca/activate or call CustomerCare at 1-888-539-7474 if you have questions about your subscription. shop.siriusxm.com/all-parts/
Channel Locked	The channel that you have requested is Locked by the radios Parental Control feature.	See the Parental Control section for more information on the Parental Control feature and how to access locked channels.

Trouble Shooting

If you have problems operating this product, refer to this section. The most common problems are listed below, along with likely causes and solutions. If a solution to your problem cannot be found here, contact your dealer or the nearest authorised Pioneer service facility.

Problem		Correct action
General	No response from the unit.	<ul style="list-style-type: none"> Restart the unit by turning off the motorcycle for ten seconds, then turning the motorcycle back on.
	No sound from the unit.	<ul style="list-style-type: none"> The unit is muted. Adjust the volume. Select the correct audio source on the unit.
USB	Cannot play a media file.	<ul style="list-style-type: none"> The file format on the USB flash drive is not supported by the unit. Change media files. The file system of the USB flash drive is not supported by the unit. Change the USB drive.
Bluetooth	Cannot make Bluetooth streaming.	<ul style="list-style-type: none"> Make sure your mobile phone is within Bluetooth range. Pair and connect your mobile phone. CarPlay or Android Auto is being connected. Unplug your mobile phone from the unit to enable Bluetooth connection.
	Poor hands-free phone call quality.	<ul style="list-style-type: none"> Check signal strength on your mobile phone. Check that the microphone is firmly attached and plugged in. Or relocate the microphone for noise reduction.
	Cannot make Bluetooth connection.	<ul style="list-style-type: none"> CarPlay/Android Auto connection disables Bluetooth on the unit. Unplug CarPlay or Android Auto from the unit to enable Bluetooth connection. The unit is already connected to a mobile device. Disconnect the current Bluetooth connection before connecting to another Bluetooth device.
Apple CarPlay	<p>Connection failed.</p> <ul style="list-style-type: none"> -Communication failed and the system is trying to connect. -Wait for a while. Then, perform the actions below if the error message is still displayed. 	<ul style="list-style-type: none"> Restart the iPhone. Disconnect the cable from the iPhone, and then connect the iPhone again after a few seconds. Turn the ignition switch to OFF and then to ON.
Android Auto	<ul style="list-style-type: none"> Connect a USB cable to get started. Your phone does not support wireless, check your phone. 	<ul style="list-style-type: none"> Check if the device is compatible with Android Auto. Android Auto app is not installed on the device. Then install the app.
	<ul style="list-style-type: none"> Connection failed. Please check your phone to confirm connection. 	<ul style="list-style-type: none"> Wi-Fi connection failed and Android Auto app did not start. Check if the Wi-Fi function on the device is turned on.
	<ul style="list-style-type: none"> Android Auto has disconnected. 	<ul style="list-style-type: none"> Turn on the Wi-Fi function on the device and the unit when you use Android Auto.
FM/AM Radio	<ul style="list-style-type: none"> Poor radio reception. 	<ul style="list-style-type: none"> FM/AM antenna is not connected or extended. Connect and secure an FM/AM antenna (not included). The antenna output wire is not connected. Connect the wire. Turn off RDS/RBDS, TA and AF.

Epsilon Electronics Inc. promises to the original purchaser of this product to repair to like-new condition or replace this product with a new or like-new unit (at Epsilon Electronics' sole and absolute discretion), should it prove to be defective in workmanship or material under normal use, for a period of two-years (2-years) from the date of purchase from a Soundstream and/or Precision Power authorized retailer. During this two-year (2-year) period, there will be no service charge for repair or replacement.

This limited warranty extends only to the original purchaser of the product, and it is not transferable to the next owner or purchaser of the motorcycle into which the product was originally installed. This warranty does not cover labor costs for removal and reinstallation of the product.

This warranty is void if the product has been damaged caused by installation or removal of the product and will not apply to any unit that is determined to have been modified or mis-used in a manner contrary to its intended purpose. This warranty is void if the product has been damaged by accident or unreasonable use, neglect, improper service or other causes not arising out of defects in material, construction, or workmanship. This warranty does not include the elimination of externally generated static or noise, or the correction of antenna problems or weak reception, damage to speakers, accessories, electrical systems, cosmetic damage or damage due to negligence, misuse, failure to follow operating instructions, accidental spills or customer applied cleaners, damage due to environmental causes such as floods, airborne fallout, chemicals, salt, hail, lightning or extreme temperatures, damage due to traffic accidents, road hazards, fire, theft, loss or vandalism, damage due to improper connection to equipment of another manufacturer or modification of existing equipment.

To file a warranty claim, please contact Soundstream's warranty office to obtain a Return Authorization number prior to shipping the product:

Phone: 1-800-724-1377
E-mail: repairs@soundstream.com
Website: soundstream.com/warranty

Epsilon Electronics Inc.
1550 South Maple Ave
Montebello, CA 90640 USA

After receiving the RA number, pack the product into suitable packaging, include dated proof of purchase, (i.e. a receipt or bill of sale) from the authorized retailer and a money order or cashier's check for return freight to Epsilon Electronics' corporate office, addressed above. Please clearly write the RA number on the outside of the packaging.

IN ORDER FOR THE TWO-YEAR (2-YEAR) WARRANTY TO BE VALID, THE PRODUCT MUST BE SHIPPED WITH PROOF OF PURCHASE FROM AN AUTHORIZED SOUNDSTREAM AND/OR PRECISION POWER AUTHORIZED RETAILER. ANY PRODUCT RECEIVED BY SOUNDSTREAM FOR WARRANTY WITHOUT AN RA NUMEBR AND PROOF OF PURCHASE FROM A SOUNDSTREAM AND/OR PRECISION POWER AUTHORIZED RETAILER WILL BE REFUSED. BY PURCHASING THIS PRODUCT, ALL WARRANTIES INCLUDING BUT NOT LIMITED TO EXPRESS WARRANTY, IMPLIED WARRANTY, WARRANTY OF MERCHANTABILITY, FITNESS FOR PARTICULAR PURPOSE, AND WARRANTY OF NON-INFRINGEMENT OF INTELLECTUAL PROPERTY ARE EXPRESSLY EXCLUDED TO THE MAXIMUM EXTENT ALLOWED BY LAW. SOUNDSTREAM NEITHER ASSUMES NOR AUTHORIZES ANY PERSON TO ASSUME FOR IT ANY LIABILITY IN CONNECTION WITH THE SALE OF THE PRODUCT. SOUNDSTREAM HAS ABSOLUTELY NO LIABILITY FOR ANY AND ALL ACTS OF THIRD PARTIES INCLUDING ITS AUTHORIZED RETAILERS OR INSTALLERS. BY PURCHASING THIS PRODUCT, THE CONSUMER AGREES AND CONSENTS THAT ALL DISPUTES BETWEEN THE CONSUMER AND SOUNDSTREAM SHALL BE RESOLVED IN ACCORDANCE WITH CALIFORNIA LAWS IN LOS ANGELES COUNTY, CALIFORNIA. Some states do not allow limitation on how long an implied warranty lasts. In such states, the limitation or exclusions of this Limited Warranty may not apply. Some states do not allow the exclusion or limitation of incidental or consequential damages. In such states, the exclusion or limitation of this Limited Warranty may not apply to you. This Limited Warranty gives you specific legal rights, and you may have other rights which vary from state to state.

FCC Notes

FCC Compliance

This device complies with Part 15 of the FCC Rules. Operation is subject to the following two conditions:

- (1) this device may not cause harmful interference, and
- (2) this device must accept any interference received, including interference that may cause undesired operation.

Warning: Changes or modifications to this unit not expressly approved by the party responsible for compliance could void the user's authority to operate the equipment.

Note: This equipment has been tested and found to comply with the limits for a Class B digital device, pursuant to Part 15 of the FCC Rules. These limits are designed to provide reasonable protection against harmful interference in a residential installation.

This equipment generates, uses and can radiate radio frequency energy and, if not installed and used in accordance with the instructions, may cause harmful interference to radio communications.

However, there is no guarantee that interference will not occur in a particular installation. If this equipment does cause harmful interference to radio or television reception, which can be determined by turning the equipment off and on, the user is encouraged to try to correct the interference by one or more of the following **measures:**

- Reorient or relocate the receiving antenna.
- Increase the separation between the equipment and receiver.
- Connect the equipment into an outlet on a circuit different from that to which the receiver is connected.
- Consult the dealer or an experienced radio/TV technician for help.

www.MotorcycleAudio.com

Follow Us on Social Media

